

Produktový cenník

Potrubný systém pre infraštruktúru

Vnútorne rozvody pre TZB

PIPELIFE

 wienerberger

Cenník
platný od
1.6.2026

 wienerberger

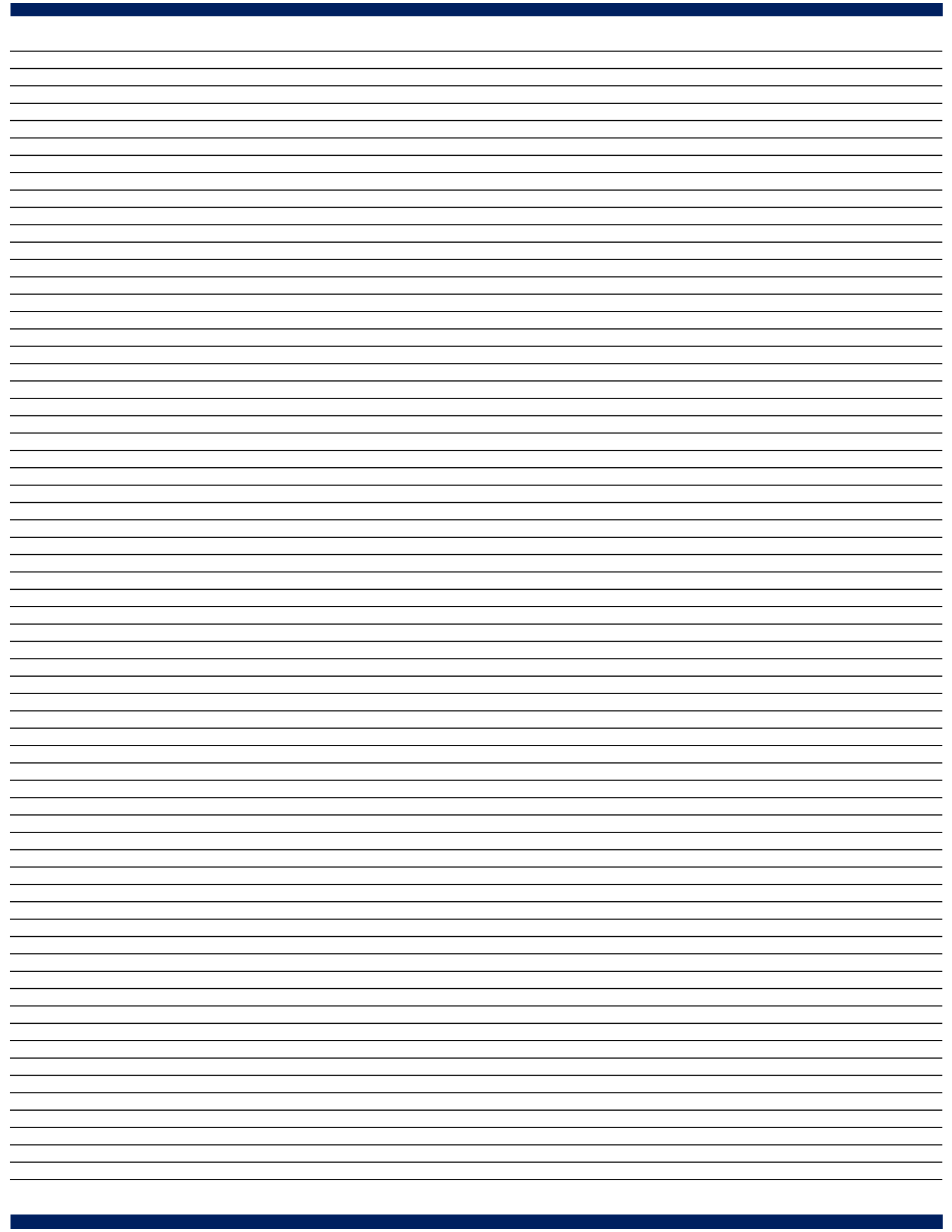

OBSAH

STRANA

KANALIZAČNÉ SYSTÉMY

PVC hladký kanalizačný systém SN 4, SN 8 koex (napenené)	1-2
PVC hladký kanalizačný systém SN 8 a SN10 kompaktný (plnostenné rúry)	3-4
PVC hladké kanalizačné tvarovky	5-8
PVC hladký kompaktný, plnostenný kanalizačný systém QUANTUM SN 12, SN 16	9-10

PP Revízne šachty DN 200, 300, 400, PRO 630, PRO 800, PRO 1000	11-22
--	-------

PP korugovaný kanalizačný systém ID PRAGMA SN 8, SN 10, SN 12, SN16 DN200-DN1400	23-28
PP hladký kompaktný plnostenný kanalizačný systém PP MASTER SN 10, SN 12 a SN 16	29-32

HDPE tlakový kanalizačný systém aj v prevedení ROBUST PIPE	33-34
--	-------

DRENÁŽNE SYSTÉMY

PVC drenážny systém	35-36
PP ID systém cestnej drenáže SN8 - SN16	37
PP OD PRAGMA SN 8 perforovaná v uhle 120°-220°-360°	38-39
RAINEO retenčný a detenčný systém pre dažďovú vodu STORMBOX a STORMBOX II	40-41

SYSTÉMY NA ROZVOD PITNEJ VODY

HDPE tlakový systém na vodu	42
HDPE RC tlakový systém na vodu AQUALINE RC1	43
HDPE RC tlakový systém na vodu AQUALINE RC2	44
HDPE RC tlakový systém na vodu s ochranným plášťom AQUALINE RC ROBUST	45
PVC tlakový systém na vodu a vŕtané studne	46-47

SYSTÉMY NA ROZVOD PLYNOV

HDPE tlakový systém na plyn, GASLINE RC2, GASLINE RC ROBUST Plyn	48
--	----

ODPADNÉ SYSTÉMY

PP vnútorný odpadný systém	49-55
PP MASTER 3 tichý vnútorný odpadný systém	56-61
PRO ROOF PEHD podtlakový systém na odvod dažďovej vody z plochých striech	62-67









SYSTÉM PRE ROZVODY TEPLEJ A STUDENEJ VODY / STLAČENÉHO VZDUCHU

PPR rúry a tvarovky	68-77
---------------------	-------

SYSTÉM PRE ROZVODY TEPLEJ A STUDENEJ VODY / ÚSTREDNÉHO A PODLAHOVÉHO VYKUROVANIA

RADOPRESS systém	78-86
RADOPRESS WATT systém stenového a stropného kúrenia / chladenia	87-90
TERRENDIS predizolovaný potrubný systém	91-97

RÚRY DN 110 - 500

Objednávaci kód		Tyče dĺžka m	Vonkajší priemer	Hrúbka steny mm	Hmotnosť kg/m	Počet ks na palete	Objednávaci SAP kód	Cena EUR/ks
KGEM110/0,5		0,5	110	3,2	1,3	76	3395000158	2,72
KGEM110/1		1				76	3395000159	4,76
KGEM110/2		2				76	3395000160	8,62
KGEM110/3		3				76	3395000161	12,80
KGEM110/5		5				76	3395000162	20,60
KGEM125/0,5		0,5	125	3,2	1,4	60	3395000163	3,53
KGEM125/1		1				60	3395000164	5,73
KGEM125/2		2				60	3395000165	10,20
KGEM125/3		3				60	3395000166	14,40
KGEM125/5		5				60	3395000167	24,20
KGEM160/0,5		0,5	160	4	2,2	33	3395000173	5,63
KGEM160/1		1				33	3395000174	9,32
KGEM160/2		2				33	3395000175	16,60
KGEM160/3		3				33	3395000176	24,20
KGEM160/5		5				33	3395000177	37,60
KGEM200/0,5		0,5	200	4,9	3,7	18	3395000178	8,48
KGEM200/1		1				18	3395000179	14,40
KGEM200/2		2				18	3395000180	25,30
KGEM200/3		3				18	3395000181	36,10
KGEM200/5		5				18	3395000182	57,40
KGEM250/1		1	250	6,2	6,1	20	3395000183	26,20
KGEM250/2		2				20	3395000184	45,60
KGEM250/3		3				20	3395000185	63,50
KGEM250/5		5				20	3395000186	102,20
KGEM315/1		1	315	7,7	8,8	12	3395000187	39,60
KGEM315/2		2				12	3395000188	68,00
KGEM315/3		3				12	3395000189	99,00
KGEM315/5		5				12	3395000190	154,00
KGEM400/1		1	400	9,8	14,9	6	3395000191	71,60
KGEM400/2		2				6	3395000192	116,30
KGEM400/3		3				6	3395000193	177,30
KGEM400/5		5				6	3395000194	251,60
KGEM500/1		1	500	12,2	27,7	4	3395000195	124,10
KGEM500/2		2				4	3395000196	202,10
KGEM500/3		3				4	3395000197	290,70
KGEM500/5		5				4	3395000198	432,00

RÚRY DN 110 - 400

Objednávaci kód		Tyče dĺžka m	Vonkajší priemer	Hrúbka steny mm	Hmotnosť kg/m	Počet ks na palete	Objednávaci SAP kód	Cena EUR/ks
KGEM110/1SN8		1	110	3,2	1,63	54	3395000095	7,40
KGEM110/2SN8		2				54	3395000096	13,30
KGEM110/3SN8		3				54	3395000097	20,30
KGEM110/5SN8		5				54	3395000098	33,40

KGEM125/1SN8		1	125	3,7	1,99	48	3395000099	8,50
KGEM125/2SN8		2				48	3395000100	15,40
KGEM125/3SN8		3				48	3395000101	22,60
KGEM125/5SN8		5				48	3395000102	38,40

KGEM160/1SN8		1	160	4,7	2,7	33	3395000103	11,90
KGEM160/2SN8		2				33	3395000104	22,10
KGEM160/3SN8		3				33	3395000105	32,20
KGEM160/5SN8		5				33	3395000106	50,90
KGEM160/6SN8	6	33	3395000107	58,40				

KGEM200/1SN8		1	200	5,9	4,2	18	3395000108	18,40
KGEM200/2SN8		2				18	3395000109	32,60
KGEM200/3SN8		3				18	3395000110	49,60
KGEM200/5SN8		5				18	3395000111	78,40
KGEM200/6SN8	6	18	3395000112	91,50				

KGEM250/1SN8		1	250	7,3	6,9	20	3395000113	32,90
KGEM250/2SN8		2				20	3395000114	56,20
KGEM250/3SN8		3				20	3395002950	78,70
KGEM250/5SN8		5				20	3395000115	128,90
KGEM250/6SN8	6	20	3395002951	153,60				

KGEM315/1SN8		1	315	9,2	10,2	12	3395000116	50,10
KGEM315/2SN8		2				12	3395000117	88,30
KGEM315/3SN8		3				12	3395002952	131,40
KGEM315/5SN8		5				12	3395000118	194,50
KGEM315/6SN8	6	12	3395002953	226,50				

KGEM400/1SN8		1	400	11,7	16,1	6	3395000119	77,80
KGEM400/2SN8		2				6	3395000120	137,90
KGEM400/3SN8		3				6	3395002954	209,00
KGEM400/5SN8		5				6	3395000121	318,00
KGEM400/6SN8	6	6	3395002955	382,00				

KGEM500/1SN8		1	500	14,6	36,9	4	3395002956	135,00
KGEM500/2SN8		2				4	3395002957	233,00
KGEM500/3SN8		3				4	3395002958	331,00
KGEM500/5SN8		5				4	3395002959	519,00
KGEM500/6SN8	6	4	3395000122	619,00				

RÚRY DN 110 - 400

Objednávaci kód	Tyče dĺžka m	Vonkajší priemer	Hrúbka steny mm	Hmotnosť kg/m	Počet ks na palete	Objednávaci SAP kód	Cena EUR/ks
KGEM160/1SN8KOM+	1	160	4,7	3,4	33	3395000123	14,90
KGEM160/2SN8KOM+	2					3395000124	29,20
KGEM160/3SN8KOM+	3					3395000125	42,50
KGEM160/6SN8KOM+	6					3395000127	81,10



KGEM200/1SN8KOM+	1	200	5,9	5,3	18	3395000128	23,70
KGEM200/2SN8KOM+	2					3395000129	42,90
KGEM200/3SN8KOM+	3					3395000130	63,80
KGEM200/6SN8KOM+	6					3395000132	119,00



KGEM250/1SN8KOM+	1	250	7,3	8,8	20	3395002960	38,50
KGEM250/2SN8KOM+	2					3395002961	67,10
KGEM250/3SN8KOM+	3					3395000133	97,20
KGEM250/6SN8KOM+	6					3395000135	177,00



KGEM315/1SN8KOM+	1	315	9,2	13,2	12	3395000136	60,40
KGEM315/2SN8KOM+	2					3395000137	102,00
KGEM315/3SN8KOM+	3					3395000138	149,00
KGEM315/6SN8KOM+	6					3395000140	265,00









KGEM400/1SN8KOM+	1	400	11,7	21,1	6	3395000141	102,00
KGEM400/2SN8KOM+	2					3395000142	175,00
KGEM400/3SN8KOM+	3					3395000143	249,00
KGEM400/6SN8KOM+	6					3395000145	455,00



KGEM500/1SN8KOM+	1	500	14,6	47,9	4	3395002963	169,00
KGEM500/2SN8KOM+	2					3395002964	285,00
KGEM500/3SN8KOM+	3					3395002965	407,00
KGEM500/6SN8KOM+	6					3395002966	762,00









RÚRY DN 110 - 500

Objednávaci kód		Tyče dĺžka m	Vonkajší priemer	Počet ks na palete	Objednávaci SAP kód	Cena EUR/ks
KGEM160/1SN10		1	160	33	3395003472	21,00
KGEM160/3SN10		3		33	3395003470	51,00
KGEM160/6SN10		6		33	3395003471	96,00
KGEM200/1SN10		1	200	18	3395003481	26,00
KGEM200/3SN10		3		18	3395003482	69,00
KGEM200/6SN10		6		18	3395003483	122,00
KGEM250/1SN10		1	250	16	3395003478	44,00
KGEM250/3SN10		3		16	3395003479	110,00
KGEM250/6SN10		6		16	3395003480	199,00
KGEM315/1SN10		1	315	9	3395003485	75,50
KGEM315/3SN10		3		9	3395003487	163,00
KGEM315/6SN10		6		9	3395003040	282,00
KGEM400/1SN10		1	400	6	3395003492	172,00
KGEM400/3SN10		3		6	3395003493	269,00
KGEM400/6SN10		6		6	3395003494	493,00
KGEM500/1SN10		6	500	4	3395003498	tel.
KGEM500/3SN10		6		4	3395003499	tel.
KGEM500/6SN10		6		4	3395003500	907,00

PVC-U hladký kanalizačný systém SN4 - SN10 (SDR41)

TVAROVKY DN 110 - 500

Objednávaci kód		Objednávaci SAP kód	Cena EUR/ks
KOLENO 15°			
KGB110/15		3395000486	1,55
KGB125/15		3395000491	2,42
KGB160/15		3395000500	3,84
KGB200/15		3395000505	7,39
KGB250/15		3395000510	18,90
KGB300/15		3395000514	30,90
KGB400/15		3395000518	75,80
KGB500/15		KGB500/15	206,30
KOLENO 30°			
KGB110/30		3395000487	1,66
KGB125/30		3395000492	2,46
KGB160/30		3395000501	4,01
KGB200/30		3395000506	7,97
KGB250/30		3395000511	20,80
KGB300/30		3395000515	31,50
KGB400/30		3395000519	13,90
KGB500/30		3395000522	231,30
KOLENO 45°			
KGB110/45		3395000488	1,69
KGB125/45		3395000493	2,70
KGB160/45		3395000502	4,09
KGB200/45		3395000507	7,50
KGB250/45		3395000512	21,40
KGB300/45		3395000516	33,00
KGB400/45		3395000520	79,70
KGB500/45		3395000523	204,20
KOLENO 67°			
KGB110/67		3395000489	1,94
KGB125/67		3395000494	3,49
KGB160/67		3395000503	5,21
KGB200/67		3395000508	11,70
KOLENO 87°			
KGB110/87		3395000490	2,04
KGB125/87		3395000495	3,05
KGB160/87		3395000504	5,05
KGB200/87		3395000509	8,94
KGB250/87		3395000513	23,90
KGB300/87		3395000517	40,80
KGB400/87		3395000521	134,10
KGB500/87		3395000524	379,20
ODBOČKA 45°			
KGEA110/110/45		3395000531	3,41
KGEA125/110/45		3395000534	4,58
KGEA125/125/45		3395000536	5,34
KGEA160/110/45		3395000541	6,49
KGEA160/125/45		3395000543	7,54
KGEA160/160/45		3395000546	8,98
KGEA200/110/45		3395000549	12,60
KGEA200/125/45		3395000551	14,60
KGEA200/160/45		3395000553	12,90
KGEA200/200/45		3395000555	17,00
KGEA250/110/45		3395000557	28,00
KGEA250/125/45		3395000558	31,20
KGEA250/160/45		3395000559	29,20
KGEA250/200/45		3395000561	33,90
KGEA250/250/45		3395000563	43,50
KGEA315/110/45		3395000565	39,80
KGEA315/125/45		3395000567	54,40
KGEA315/160/45		3395000568	38,90

PVC-U hladký kanalizačný systém SN4 - SN10 (SDR41)

TVAROVKY DN 110 - 500









Objednávaci kód		Objednávaci SAP kód	Cena EUR/ks
KGEA315/200/45		3395000570	54,40
KGEA315/250/45		3395000572	85,50
KGEA315/315/45		3395000574	107,30
KGEA400/160/45		3395000576	101,00
KGEA400/200/45		3395000578	105,20
KGEA400/250/45		3395000580	150,00
KGEA400/315/45		3395000581	170,80
KGEA400/400/45		3395000583	296,90
KGEA500/160/45		3395003855	208,30
KGEA500/200/45		3395003954	219,80
KGEA500/250/45		3395004049	219,80
KGEA500/315/45		3395004050	269,80
KGEA500/400/45		3395004051	599,00
KGEA500/500/45		3395003030	609,40

Objednávaci kód		Objednávaci SAP kód	Cena EUR/ks
KGEA110/110/87		3395000533	3,24
KGEA125/110/87		3395000535	4,94
KGEA125/125/87		3395000537	5,04
KGEA160/110/87		3395000542	6,71
KGEA160/125/87		3395000544	6,92
KGEA160/160/87		3395000548	7,40
KGEA200/110/87		3395000550	12,80
KGEA200/125/87		3395000552	12,80
KGEA200/160/87		3395000554	15,00
KGEA200/200/87		3395000556	15,50
KGEA250/160/87		3395000560	27,20
KGEA250/200/87		3395000562	31,20
KGEA250/250/87		3395000564	35,90
KGEA315/110/87		3395000566	54,80
KGEA315/125/87		3395004218	64,20
KGEA315/160/87		3395000569	36,90
KGEA315/200/87		3395000571	64,20
KGEA315/250/87		3395000573	85,50
KGEA315/315/87		3395000575	62,00
KGEA400/160/87		3395000577	96,20
KGEA400/200/87		3395000579	101,00
KGEA400/250/87		KGEA400/250/87	126,00
KGEA400/315/87		3395000582	150,00
KGEA400/400/87		3395000584	204,20
KGEA500/160/87		3395004263	206,30
KGEA500/200/87		3395004016	206,30
KGEA500/250/87		KGEA500/250/87	194,80
KGEA500/315/87		3395000585	301,00
KGEA500/400/87		3395000586	325,00
KGEA500/500/87		3395004095	314,60

KGDA110/45		3395000527	17,30
KGDA125/45		3395000529	28,80
KGDA160/45		3395000530	61,30
KGDA110/87		DVOJITÁ ODBOČKA 87°	3395000528

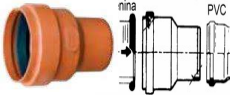

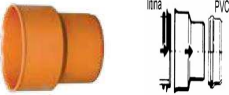



PVC-U hladký kanalizačný systém SN4 - SN10 (SDR41)

TVAROVKY DN 110 - 500

Objednací kód			Objednací SAP kód	Cena EUR/ks
KGEAM250/160	NAVRTÁVACIA ODBOČKA 90° 		3395000588	48,50
KGEAM315/160			3395000589	58,30
KGEAM400/160			3395000591	60,20
KGEAM500/160			3395004139	66,00
KGEAMK160	UŤAHOVACÍ KLÍČ		3395000593	6,47
KGEAMV152	KORUNKOVÝ VRTÁK		3395000594	219,80
KGR125/110	REDUKCIA 		3395000621	1,85
KGR160/110			3395000624	2,48
KGR160/125			3395000625	3,59
KGR200/125			3395000628	7,97
KGR200/160			3395000629	5,64
KGR250/160			3395000630	17,10
KGR250/200			3395000631	17,50
KGR315/160			3395000632	33,00
KGR315/200			3395000633	35,90
KGR315/250			3395000634	30,10
KGR400/315			3395000636	52,50
KGR500/400		3395000637	163,50	
KGU110	PRESUVKA 		3395000654	1,59
KGU125			3395000655	2,39
KGU160			3395000657	3,64
KGU200			3395000658	6,65
KGU250			3395000659	16,60
KGU315			3395000660	24,70
KGU400			3395000661	54,40
KGU500		3395000662	132,20	
KGUS110	PRECHOD KAMENINA - PVC 		3395000668	7,97
KGUS125			3395000669	12,80
KGUS160			3395000670	18,40
KGUS200			3395000671	36,90
KGUSM110L	PRECHOD PVC - KAMENINA TREBA DOOBJEDNAŤ KGRR 		3395000674	4,31
KGUSM125L			3395000675	4,79
KGUSM160L			3395000676	5,27
KGUSM200L			3395000677	17,70
KGUSM250L			3395000678	87,40
KGUG110	PRECHOD LIATINA - PVC Nutné doobjednať krúžky KAME 		3395000664	3,26
KGUG125			3395000665	4,03
KGUG160			3395000666	4,85
KAME110	Tesniaci krúžok na PRECHOD PVC 		3395000472	2,25
KAME125			3395000473	4,65
KAME160			3395000474	5,06
KAME200			3395000475	9,32

PVC-U hladký kanalizačný systém SN4 - SN10 (SDR41)







TVAROVKY DN 110 - 500









Objednávaci kód		Objednávaci SAP kód	Cena EUR/ks
ZÁTKA DO HRDLA			
KGM110		3395000612	0,74
KGM125		3395000613	1,01
KGM160		3395000615	1,66
KGM200		3395000616	2,83
KGM250		3395000617	9,54
KGM315		3395000618	16,30
KGM400		3395000619	33,00
KGM500		3395000620	124,00
ZÁTKA NA HLADKÝ KONIE			
KGK110		3395000595	1,13
KGK125		3395000596	1,39
KGK160		3395000597	1,96
KGK200		3395000598	3,20
KGK250		3395000599	7,19
KGK315		3395000600	10,90
KGK400		3395000601	22,70
ŠACHTOVÝ PRECHOD PIESKOVANÝ			
KGAMS110		KGAMS110	16,30
KGAMS125		3395003861	16,60
KGAMS160		3395000481	21,00
KGAMS200		3395000482	23,50
KGAMS250		3395000483	35,40
KGAMS315		3395000484	51,70
KGAMS400		3395000485	87,40
KGAMS500		3395003843	179,20
ČISTIACI KUS			
KGRE110		3395000639	5,55
KGRE125		3395000640	7,74
KGRE160		3395000642	18,00
KGRE200		3395000643	27,80
KGRE250		3395000644	80,80
KGRE315		3395000645	181,30
TESNIACI KRÚŽOK			
BL110		3395002194	1,03
BL125		3395002195	1,37
BL160		3395002197	1,50
BL200		3395002198	1,96
BL250		3395002199	4,32
BL315		3395002200	5,75
BL400		3395002201	10,05
BL500		3395004350	24,90
SPÄTNÁ KLAPKA			
KGKLAP110		3395000603	52,50
KGKLAP125		3395000604	64,20
KGKLAP160		3395000605	66,00
KGKLAP200		3395000606	147,90
KGKLAP250		3395000607	287,50
KGKLAP315		3395000608	493,80
KGKLAP400		3395002967	814,60

QUANTUM hladký kanalizačný systém SN12 - SN16

PVC HLADKÉ RÚRY KOMPAKTNÉ, PLNOSTENNÉ PRE GRAVITAČNÝ ROZVOD KANALIZÁCIE

RÚRY DN 160 - 400

Objednávaci kód	SN 12	Tyče dĺžka m	Vonkajší priemer	Hrúbka steny mm	Hmotnosť kg/m	Počet ks na palete	Objednávaci SAP kód	Cena EUR/ks
Q12-160/1		1	160	5,5	3,9	33	3395000052	17,60
Q12-160/3		3						47,00
Q12-160/6		6						91,00
Q12-200/1		1	200	6,6	5,5	18	3395000055	24,90
Q12-200/3		3						65,20
Q12-200/6		6						126,00
Q12-250/1		1	250	8,2	9,5	16	3395000058	44,00
Q12-250/3		3						109,00
Q12-250/6		6						205,00
Q12-315/1		1	315	10,0	14,9	9	3395002884	77,00
Q12-315/3		3						172,00
Q12-315/6		6						307,00
Q12-400/1		1	400	12,6	24,0	6	3395000062	119,00
Q12-400/3		3						286,00
Q12-400/6		6						499,00
Q12-500/6		6	500	19,0		4	3395000065	839,00
Q12-600/6		6	630	23,4		1	3395000066	tel.
Q12-800/6		6	800	29,5		1	Q12-800/6+	tel.
Objednávaci kód	SN 16	Tyče dĺžka m	Vonkajší priemer	Hrúbka steny mm	Hmotnosť kg/m	Počet ks na palete	Objednávaci kód	Cena EUR/ks
Q16-160/6		6	160	6,0	4,7	33	3395003282	105,00
Q16-200/6		6	200	7,5	7,9	18	3395003283	148,00
Q16-250/6			6	250	9,3	12	16	3395003284
Q16-315/6	6		315	11,7	17,2	9	3395003285	392,00
Q16-400/6			6	400	14,9	29,7	6	3395000067
Q16-500/6		6	500	19,0		4	Q16-500/6+	1 072,00
Q16-600/6		6	630	23,4		1	Q16-600/6+	tel.
Q16-800/6		6	800	29,5		1	Q16-800/6+	tel.

Objednávaci kód			Objednávaci SAP kód	Cena EUR/ks
Q-KGB160/15	KOLENO 15°		3395000031	20,20
Q-KGB200/15			3395000034	29,40
Q-KGB250/15			3395003309	49,30
Q-KGB315/15			3395000038	99,10
Q-KGB400/15			3395000039	176,00
Q-KGB160/30	KOLENO 30°		3395000032	17,40
Q-KGB200/30			3395000035	36,40
Q-KGB250/30			3395003310	68,10
Q-KGB315/30			3395003363	117,40
Q-KGB400/30			3395004752	211,20
Q-KGB160/45	KOLENO 45°		3395000033	17,70
Q-KGB200/45			3395000036	39,00
Q-KGB250/45			3395003311	69,00
Q-KGB315/45			3395003364	120,00
				320,00
Q-KGB160/87	KOLENO 87°		3395004356	22,00
Q-KGB250/87			3395003312	112,00
Q-KGB315/87			3395003365	187,00
Poznámka: Kolená Q-KGB160 sa dodávajú v šedej farbe				
Q-KGEA200/160/45	ODBOČKA 45°		3395000041	76,74
Q-KGEA200/200/45			3395000042	93,22
Q-KGEA250/160/45			3395000043	103,00
Q-KGEA250/200/45			3395003381	123,00
Q-KGEA250/250/45			3395005210	160,00
Q-KGEA315/160/45			3395000044	158,00
Q-KGEA315/200/45			3395000045	172,00
Q-KGEA315/250/45			Q-KGEA315/250/45	199,00
Q-KGEA315/315/45			3395003370	337,00
Q-KGEA400/160/45			3395003996	264,00
Q-KGEA400/200/45			3395000046	287,00
Q-KGEA400/250/45			3395004041	301,00
Q-KGEA400/315/45			Q-KGEA400/315/45	561,00
Q-KGEA400/400/45			Q-KGEA400/400/45	710,00
Q-KGM250			ZÁTKA	
Q-KGM315	3395004951	85,00		
Q-KGM400	Q-KGM400	132,00		
Q-KGMM160	SPOJKA SO ZARÁŽKOU		3395004836	15,60
Q-KGMM200			3395004837	24,00
Q-KGMM250			3395004004	43,00
Q-KGMM315			3395004005	49,00
Q-KGMM400			3395004840	140,00
Poznámka: Spojka so zarážkou Q-KGMM160 sa dodáva v šedej farbe				
Q-KGU160	PRESUVNÁ SPOJKA		3395000047	15,20
Q-KGU200			3395000048	27,00
Q-KGU250			3395000049	45,00
Q-KGU315			3395000050	65,00
Q-KGU400			3395000051	151,00
Poznámka: Presuvná spojka Q-KGU160 sa dodáva v šedej farbe				
Q-K160	NÁHRADNÉ TESNIENIE		3395004807	0,90
Q-K200			3395004808	1,48
Q-K250			3395002220	4,24
Q-K315			3395002221	6,54
Q-K400			3395004181	12,20

PP ULIČNÉ VPUSTE DN300

Objednávaci kód	Objednávaci kód	Cena EUR/ks
KJ300/160/1000	3395004118	102,00
KJ300/160/1200	3395004196	111,00
KJ300/160/1300	3395003048	115,00
KJ300/160/1400	3395003043	119,00
KJ300/160/1500	3395001190	124,00
KJ300/200/1000	3395003308	106,90
KJ300/200/1200	KJ300/200/1200	116,00
KJ300/200/1300	3395004096	119,00
KJ300/200/1400	KJ300/200/1400	124,00
KJ300/200/1500	KJ300/200/1500	127,00

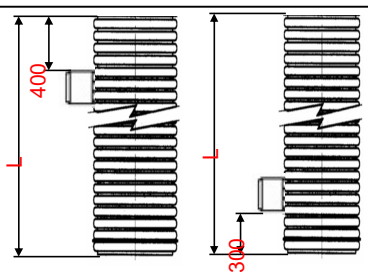

Možnosť zvoliť horný / spodný vývod. Cena sa nelíši.

PP ULIČNÉ VPUSTE DN400

Objednávaci kód	Objednávaci kód	Cena EUR/ks
KJ400/160/1000	3395001197	128,00
KJ400/160/1100	3395001198	136,00
KJ400/160/1300	3395004741	149,00
KJ400/160/1500	3395001199	155,00
KJ400/200/1000	3395001201	134,00
KJ400/200/1200	3395001202	148,00
KJ400/200/1300	3395004725	152,00
KJ400/200/1500	3395001203	157,00
Mreža 500x500	3395002823	tel.
Bahenný kôš	3395002820	tel.

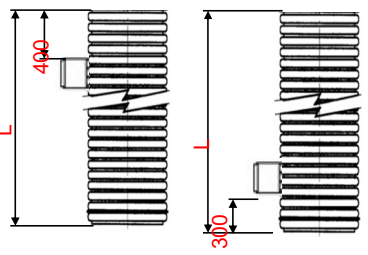

Možnosť zvoliť horný / spodný vývod. Cena sa nelíši.



PRO Uličné vpusťe so sifónovou uzávierkou

T30K/12,5T	420x340 mm		NOVINKA	3395005191	156,00
T50K/25T				3395005192	206,00
Držiak koša T30K				3395005195	15,00
Držiak koša T50K				3395005196	15,00
Bahenný kôš PE 250 mm				3395005193	35,00
PRO400/315Redukcia	Redukcia pre pripojenie teleskopu s mrežou napriamo			3395004950	34,00
PRO MREŽA veľká	600x400 mm			3395005118	298,00
PRO roznášací prsteneč				3395005116	37,00
PRO redukovaný prsteneč				3395005117	37,00
ID PRK400				3395002213	52,90
ID PR400/6WS				3395000082	238,00
ID PR400/1WS					
Tesnenie ID400 vonkajšie				3395005115	7,90
PRO110SIFON				3395004946	12,00
PRO125SIFON				3395004947	12,00
PRO160SIFON				3395004948	13,00
PRO200SIFON				3395004949	13,00
Zátka D110				3395005114	1,90
PRO400VPUŠŤ	Telo vpusťe			3395004945	49,00

Ceny sú bez DPH

Cenník platný od 1.6.2026



PP REVÍZNE ŠACHTY DN200 S PVC HLADKÝM PREDĹŽENÍM

Objednávaci kód				Objednávaci SAP kód	Cena EUR/ks
T15	Poklop plný	1,5 t		3395001238	65,00
T20	Poklop plný	40 t		3395001237	86,00
KGEM200/1	Predĺženie			3395000179	Cenník PVC kanalizačné rúry SN 4
KGEM200/2	Dodáva sa PVC kanalizačná rúra SN 4			3395000180	
KGEM200/3				3395000181	
KGEM200/5				3395000182	
KGSGK200/110	Priebežné dno			3395001171	44,00
KGSGK200/160				3395001172	59,60
KGSGK200/200				3395001173	109,00

ŠACHTY DN315

KGDOV315	Plastový pochádzny poklop 1,5 t pre nový typ šachiet 315 na vlnovec			3395001168	19,00
----------	---	--	---	------------	-------

TELESKOPICKÉ POKLOPY

T05	Poklop plný 1,5 t manžetu nutné objednať zvlášť!!!!			3395001235	64,00
T05K	Poklop mreža 1,5 t manžetu nutné objednať zvlášť!!!!			3395004859	72,00
T30	Poklop plný 12,5 t manžetu nutné objednať zvlášť!!!!			3395001239	84,00
T30K	Poklop mreža 12,5 t manžetu nutné objednať zvlášť!!!!			3395001240	97,00
T40	Poklop plný 40 t manžetu nutné objednať zvlášť!!!!			3395001241	89,00
T40K	Poklop mreža 40 t manžetu nutné objednať zvlášť!!!!			3395004860	104,00
3395001206	Manžeta teleskopu na vlnovcové predĺženie ID315			3395001206	15,60

PPSR315/1,25SN2		PP vlnovcové predĺženie ID315/1,25 m SN 2	3395001227	31,00
PPSR315/2SN2		PP vlnovcové predĺženie ID315/2 m SN 2	3395001228	44,00
PPSR315/3SN2		PP vlnovcové predĺženie ID315/3 m SN 2	3395004739	68,00
PPSR315/6SN2		PP vlnovcové predĺženie ID315/6 m SN 2	3395001229	121,00
PPSR315/6SN4		PP vlnovcové predĺženie ID315/6 m SN 4	3395001230	141,00

Súčasťou každého dna je tesnenie DN300

PPSPK315/160	Priebežné dno			3395001224	29,00
PPSPK315/200	Napojenie hladké KG rúry, predĺženie PP vlnovcová rúra PPSR315/..			3395001225	34,00

PPSGR315/160	Zberné dno			3395001212	34,00
PPSGR315/200	Napojenie hladké KG rúry, predĺženie PP vlnovcová rúra PPSR315/..			3395001215	41,00

PPSGR315/160L				3395001213	35,00
PPSGR315/200L				3395001216	39,00

PPSGR315/160P				3395001214	35,00
PPSGR315/200P				PPSGR315/200P	39,00

PP REVÍZNE ŠACHTY DN400 S PVC HLADKÝM PREDĽŽENÍM

Objednávaci kód		Objednávaci SAP kód	Cena EUR/ks
KGDOV400	Plastový pochádzny poklop DN 400 1,5 t	3395001169	12,60
KGDOV400L	Liatinový poklop DN400 s rámom do 1,5 t	3395001170	32,00

TELESKOPICKÉ POKLOPY

T05	Poklop plný 1,5 t manžetu nutné objednať zvlášť!!!	3395001235	64,00
T05K	Poklop mreža 1,5 t manžetu nutné objednať zvlášť!!!	3395004859	72,00
T30	Poklop plný 12,5 t manžetu nutné objednať zvlášť!!!	3395001239	84,00
T30K	Poklop mreža 12,5 t manžetu nutné objednať zvlášť!!!	3395001240	97,00
T40	Poklop plný 40 t manžetu nutné objednať zvlášť!!!	3395001241	89,00
T40K	Poklop mreža 40 t manžetu nutné objednať zvlášť!!!	3395004860	104,00



3395001243	Manžeta teleskopu na hladké predĺženie DN400	3395001243	15,60
------------	--	------------	-------



KGSR400/1	Predĺženie		3395001186	35,00
KGSR400/1,5			3395001187	51,00
KGSR400/2			3395001188	67,00
KGSR400/6			3395001189	187,00

KGSGK400/160KLAP	Priebežné dno so spätnou klapkou	3395003976	199,00
KGSGK400/200KLAP		3395004176	199,00

KGSGK400/160	Priebežné dno		3395001176	46,00
KGSGK400/200			3395001177	49,00
KGSGK400/250			3395001178	185,00
KGSGK400/315			3395001179	209,00
KGSGK400/400			3395001180	244,00

KGSGR400/110	Zberné dno		3395001181	55,00
KGSGR400/160			3395001182	64,00
KGSGR400/200			3395001183	76,00
KGSGR400/250			3395001184	142,00
KGSGR400/315			3395001185	286,00

PP REVÍZNE ŠACHTY DN400 S PP KORUG PREDLŽENÍM

Objednávaci kód		Objednávaci SAP kód	Cena EUR/ks
KGDOV400	Plastový pochádzny poklop s rámom DN 400 1,5 t	3395001169	12,60
KGDOV400L	Liatinový poklop DN400 s rámom do 1,5 t	3395001170	32,00



TELESKOPICKÉ POKLOPY

T05	Poklop plný 1,5 t manžetu nutné objednať zvlášť!!!	3395001235	64,00
T05K	Poklop mreža 1,5 t manžetu nutné objednať zvlášť!!!	3395004859	72,00
T30	Poklop plný 12,5 t manžetu nutné objednať zvlášť!!!	3395001239	84,00
T30K	Poklop mreža 12,5 t manžetu nutné objednať zvlášť!!!	3395001240	97,00
T40	Poklop plný 40 t manžetu nutné objednať zvlášť!!!	3395001241	89,00
T40K	Poklop mreža 40 t manžetu nutné objednať zvlášť!!!	3395004860	104,00



3395001244	Manžeta teleskopu na korugované predĺženie DN400	3395001244	15,40
------------	--	------------	-------

Predĺženie PP korugované s dvojitou stenou.

PPSR400/1SN4		PP korugované predĺženie OD400/1 m SN 4	3395001231	29,00
PPSR400/2SN4		PP korugované predĺženie OD400/2 m SN 4	3395001232	58,00
PPSR400/6SN4		PP korugované predĺženie OD400/6 m SN 4	3395001233	167,00

Súčasťou každého dna je tesnenie DN400



PPSGK400/160	Priebežné dno		3395001208	33,00
PPSGK400/200	Napojenie hladké KG rúry, predĺženie PP korugovaná rúra PPSR400/..		3395001209	36,00
PPSGK400/250			3395003298	185,00
PPSGK400/315			3395001210	204,00
PPSGK400/400			3395001211	234,00

Súčasťou každého dna je tesnenie DN400



	Zberné dno			
PPSGR400/160	Napojenie hladké KG rúry, predĺženie PP korugovaná rúra PPSR400/..		3395001218	37,00
PPSGR400/200			3395001221	42,00
PPSGR400/160L			3395001219	37,00
PPSGR400/200L			3395001222	41,00
PPSGR400/160P			3395001220	37,00
PPSGR400/200P			3395001223	41,00

PPDW400	Náhradné tesnenie dna s korugovaným predĺžením	3395003161	8,99
---------	--	------------	------

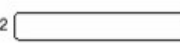
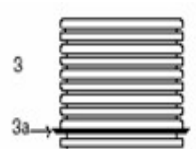
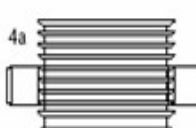
PP ŠACHTY PRO630 mm

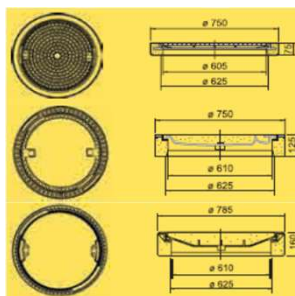
Objednávaci kód		Objednávaci SAP kód	Cena EUR/ks
POKLOP	 <p>Špecifikácia ďalej</p>	POKLOP	
6TP535805		3395001490	147,00
6RA545535	 <p>Manžeta pre teleskop</p>	3395001486	39,00
KGBET630	 <p>Betónový roznášací prstenec Plastový roznášací prstenec</p>	3395001531	99,00
T3615		3395001543	66,00
6R6301000	 <p>Predĺženie PP D630/1000 Predĺženie PP D630/1500 Predĺženie PP D630/2000 Predĺženie PP D630/6000</p>	3395001482	95,00
6R6301500		3395001483	143,00
6R6302000		3395001484	181,00
6R6306000		3395001485	499,00
PRK630	 <p>Tesniaci krúžok</p>	3395001537	22,50
ŠACHTOVÉ DNO	Špecifikácia ďalej	ŠACHTOVÉ DNO	

Objednávaci kód	POKLOP BEGU, Betón - liatina	Objednávaci kód	Cena EUR/ks
ROPP-63- POKLOP	PP POKLOP DN600 A15	3395003525	112,50
PL600/A15		3395001533	144,00
PL600/B125		3395001534	191,00
PL600/C250		PL600/C250	191,00
PL600/D400		3395001535	196,00

Objednávaci kód	Použitie pri všetkých typoch šacht Umožňuje pripojenie KG rúr pod uhlom +/- 7,5° FLEXI HRDLO	Objednávaci kód	Cena EUR/ks
6STADS160		3395001487	11,50
6STADS200		3395003849	19,80
6STADS250		3395003850	54,00
6STADS315		3395001488	73,00
6STADS400		3395001489	163,00
Flex Adapter 160/7,5°		3496103069	13,50
Flex Adapter 200/7,5°		3496103070	14,50
Flex Adapter 250/7,5°		3496103071	24,50
Flex Adapter 315/7,5°		3496102786	40,70
Flex Adapter 400/7,5°		3496103169	61,90

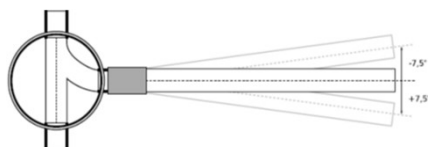

Ceny sú bez DPH

Cenník platný od 1.6.2026

PP VSTUPNÉ ŠACHTY PRO800

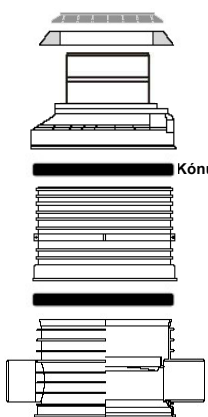

Objednávaci kód	PP VSTUPNÉ ŠACHTY DN800 mm	Objednávaci SAP kód	Cena EUR/ks
Prevedenie s betónovým			
POKLOP	Špecifikácia ďalej	POKLOP	
KGBET630	Betónový roznašací prstenec	3395001531	99,00
T3615	Plastový roznašací prstenec	3395001543	66,0
8CFE63800	Kónus s nadstavcom DN800/600 (250 mm)	3395001508	164,0
8RS045800	Tesnenie DN800 mm	3395001511	32,0
8RR800500	Predĺžovacia skruž DN800/500 mm	3395001510	269,0
8RS045800	Tesnenie DN800 mm	3395001511	32,0
ŠACHTOVÉ DNO	Špecifikácia ďalej	ŠACHTOVÉ DNO	





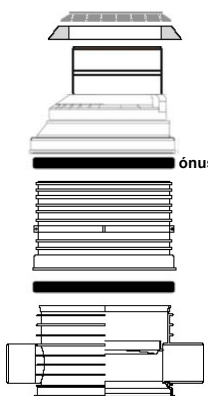

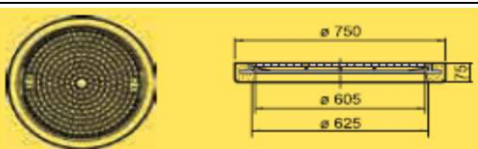
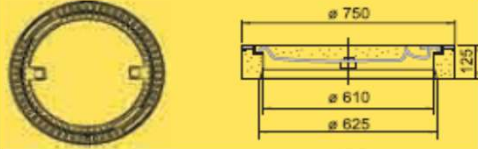





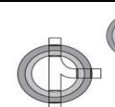
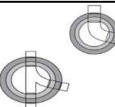
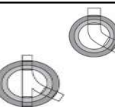
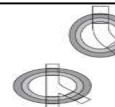
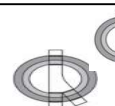

PP VSTUPNÉ ŠACHTY PRO1000

Objednávaci kód	PP VSTUPNÉ ŠACHTY DN1000 mm	Objednávaci kód	Cena EUR/ks
Prevedenie s betónovým			
POKLOP	Špecifikácia ďalej	POKLOP	
KGBET630	Betónový roznašací prstenec	3395001531	99,00
T3615	Plastový roznašací prstenec	3395001543	66,0
1CFE63100	Kónus s nadstavcom DN1000/600 (250 mm)	3395001400	269,0
1RS045100	Tesnenie DN1000 mm	3395001405	38,0
1RR100500	Predĺžovacia skruž DN1000/500 mm	3395001402	285,0
1RS045100	Tesnenie DN1000 mm	3395001405	38,0
ŠACHTOVÉ DNO	Špecifikácia ďalej	ŠACHTOVÉ DNO	



















Objednávaci kód	POKLOP BEGU, Betón - liatina	Objednávaci kód	Cena EUR/ks
PL600/A15		3395001533	144,0
PL600/B125		3395001534	191,0
PL600/C250		PL600/C250	191,0
PL600/D400		3395001535	196,0

PP ŠACHTOVÉ DNÁ PRO630

Objednávaci kód		0° - 180°	Priemer napojenia	Objednávaci SAP kód	Cena EUR/ks
616000000		0° - 180°	160	3395001407	189,20
620000000			200	3395001421	196,90
616000090		0° - 90° - 180°	160	3395001409	320,00
620000090			200	3395001422	331,00
616090000			160	3395001418	204,60
620090000			200	3395001431	206,80
616000105		0° - 105° - 180°	160	3395001410	320,00
620000105			200	3395001423	331,00
616105000			160	3395003053	320,00
620105000			200	3395003054	331,00
616000120		0° - 120° - 180°	160	3395001411	320,00
620000120			200	3395001424	331,00
616120000			160	3395003055	320,00
620120000			200	3395003056	331,00
616000135		0° - 135° - 180°	160	3395001412	320,00
620000135			200	3395001425	331,00
616135000			160	3395003057	320,00
620135000			200	3395001433	331,00
616000150		0° - 150° - 180°	160	3395003058	320,00
620000150			200	3395001426	331,00
616150000			160	3395003059	320,00
620150000			200	3395003060	331,00
616000210		0° - 180° - 210°	160	3395001414	320,00
620000210			200	3395003061	331,00
616000225		0° - 180° - 225°	160	3395001415	277,00
620000225			200	3395001428	331,00
616000240		0° - 180° - 240°	160	3395001416	320,00
620000240			200	3395003062	331,00
616000255		0° - 180° - 255°	160	3395003063	320,00
620000255			200	3395001428	331,00
616000270		0° - 180° - 270°	160	3395001417	204,60
620000270			200	3395001429	206,80
616090225		0° - 90° - 180° - 225°	160	3395003065	313,60
620090225			200	3395003066	307,50
616090270		0° - 90° - 180° - 270°	160	3395001419	215,60
620090270			200	3395001432	224,40
616135225		0° - 135° - 180° - 225°	160	3395001420	215,60
620135225			200	3395001434	224,40
616135270		0° - 135° - 180° - 270°	160	3395003067	313,60
620135270			200	3395003068	307,50

















PP ŠACHTOVÉ DNÁ PRO630

Objednávaci kód			Priemer napojenia	Objednávaci SAP kód	Cena EUR/ks
62500090		0° - 90° resp. 0° - 270°	250	3395001436	367,80
63100090			315	3395001458	391,50
64000090			400	3395002999	570,00
62500105		0° - 105° resp. 0° - 255°	250	3395003070	367,80
63100105			315	3395003071	413,30
64000105			400	3395001475	570,00
62500120		0° - 120° resp. 0° - 240°	250	3395001437	367,80
63100120			315	3395003072	413,30
64000120			400	3395003073	570,00
62500135		0° - 135° resp. 0° - 225°	250	3395001438	367,80
63100135			315	3395001461	413,30
64000135			400	3395003074	570,00
62500150		0° - 150° resp. 0° - 210°	250	3395001439	367,80
63100150			315	3395003075	430,00
64000150			400	3395001476	570,00
62500165		0° - 165° resp. 0° - 195°	250	3395001440	367,80
63100165			315	3395001463	413,30
64000165			400	3395001477	570,00
62500180		0° - 180°	250	3395001441	234,30
63100180			315	3395001464	255,20
64000180			400	3395001478	562,50
625091827		0° - 90° - 180° - 270°	250	3395001451	286,00
631091827			315	3395001470	317,90
640091827			400	3395003002	622,50
625091800		0° - 90° - 180°	250	3395001450	414,60
631091800			315	3395001469	430,70
640091800			400	3395001480	622,50
625001827		0° - 180° - 270°	250	3395001445	414,60
631001827			315	3395001468	430,70
640001827			400	3395001479	622,50
625131822		0° - 135° - 180° - 225°	250	3395001455	437,40
625131800		0° - 135° - 180°	250	3395003076	414,60
625001822		0° - 180° - 225°	250	3395003077	414,60
616000001		Koncové dno	160	3395001408	197,10
620000001			200	3395003078	196,80
625000001			250	3395003079	281,20
631000001			315	3395001457	288,90
640000001			400	3395001474	372,00
600000000		Slepé dno		3395001406	189,40

















Ceny sú bez DPH

Cenník platný od 1.6.2026

PP ŠACHTOVÉ DNÁ PRO800

Objednávaci kód			Priemer napojenia	Objednávaci SAP kód	Cena EUR/ks
81600000 82000000		0° - 180°	160 200	3395001492 3395001497	401,50 412,50
816090000 820090000		0° - 90° - 180°	160 200	3395001496 3395001501	607,00 577,50
816105000 820105000		0° - 105° - 180°	160 200	3395003080 3395003081	634,00 642,00
816120000 820120000		0° - 120° - 180°	160 200	3395003082 3395003083	634,00 642,00
816135000 820135000		0° - 135° - 180°	160 200	3395003084 3395003085	634,00 642,00
816150000 820150000		0° - 150° - 180°	160 200	3395003086 3395003087	634,00 642,00
816000210 820000210		0° - 180° - 210°	160 200	3395003088 3395003089	634,00 642,00
816000225 820000225		0° - 180° - 225°	160 200	3395003090 3395003091	634,00 642,00
816000240 820000240		0° - 180° - 240°	160 200	3395003092 3395003093	634,00 642,00
816000255 820000255		0° - 180° - 255°	160 200	3395003094 3395003095	634,00 642,00
816000270 820000270		0° - 180° - 270°	160 200	3395001495 3395001500	596,00 577,50
816090225 820090225		0° - 90° - 180° - 225°	160 200	3395003096 3395003097	645,00 617,70
816090270 820090270		0° - 90° - 180° - 270°	160 200	3395003098 3395001502	645,00 429,00
816135225 820135225		0° - 135° - 180° - 225°	160 200	3395004058 3395002912	645,00 429,00
816135270 820135270		0° - 135° - 180° - 270°	160 200	3395004769 3395004770	645,00 617,70

















PP ŠACHTOVÉ DNÁ PRO800

Objednávaci kód			Priemer napojenia	Objednávaci SAP kód	Cena EUR/ks
82500090		0° - 90° resp. 0° - 270°	250	3395003164	456,50
83100090			315	3395003165	497,30
84000090			400	3395003166	800,80
82500105		0° - 105° resp. 0° - 255°	250	3395003167	577,80
83100105			315	3395003168	610,20
84000105			400	3395003169	800,80
82500120		0° - 120° resp. 0° - 240°	250	3395003099	577,80
83100120			315	3395003100	610,20
84000120			400	3395003101	800,80
82500135		0° - 135° resp. 0° - 225°	250	3395003102	577,80
83100135			315	3395003103	610,20
84000135			400	3395003104	800,80
82500150		0° - 150° resp. 0° - 210°	250	3395003105	577,80
83100150			315	3395003106	610,20
84000150			400	3395003107	800,80
82500165		0° - 165° resp. 0° - 195°	250	3395003108	577,80
83100165			315	3395003109	610,20
84000165			400	3395003110	800,80
82500180		0° - 180°	250	3395001503	456,50
83100180			315	3395003111	473,00
84000180			400	3395001506	495,00
825091827		0° - 90° - 180° - 270°	250	3395003112	456,50
831091827			315	3395003113	497,30
840091827			400	3395003114	696,00
825091800		0° - 90° - 180°	250	3395003115	602,10
831091800			315	3395002913	497,30
840091800			400	3395001507	696,00
825001827		0° - 180° - 270°	250	3395003117	602,10
831001827			315	3395003118	497,30
840001827			400	3395003119	696,00
825131822		0° - 135° - 180° - 225°	250	3395003120	627,80
831131822			315	3395003121	722,80
			400		
825131800		0° - 135° - 180°	250	3395003122	602,10
831131800			315	3395003123	722,80
825001822		0° - 180° - 225°	250	3395003124	602,10
831001822			315	3395003125	722,80
816000001		Koncové dno	160	3395001493	332,00
820000001			200	3395003126	336,50
825000001			250	3395003127	334,80
831000001			315	3395003128	358,60
840000001			400	3395001504	465,00
800000000		Slepé dno		3395001491	319,00

















Ceny sú bez DPH

Cenník platný od 1.6.2026

PP ŠACHTOVÉ DNÁ PRO1000

Objednávaci kód			Priemer napojenia	Objednávaci SAP kód	Cena EUR/ks
11600000 12000000		0° - 180°	160 200	3395001247 3395001253	430,10 433,40
116090000 120090000		0° - 90° - 180°	160 200	3395001250 3395001259	645,00 655,00
116105000 120105000		0° - 105° - 180°	160 200	3395003129 3395003130	685,00 698,00
116120000 120120000		0° - 120° - 180°	160 200	3395003131 3395003132	685,00 698,00
116135000 120135000		0° - 135° - 180°	160 200	3395001252 3395003133	685,00 698,00
116150000 120150000		0° - 150° - 180°	160 200	3395003134 3395003135	685,00 698,00
116000210 120000210		0° - 180° - 210°	160 200	3395003136 3395003137	685,00 698,00
116000225 120000225		0° - 180° - 225°	160 200	3395003138 3395003139	685,00 698,00
116000240 120000240		0° - 180° - 240°	160 200	3395003140 3395003141	685,00 698,00
116000255 120000255		0° - 180° - 255°	160 200	3395003142 3395003143	685,00 698,00
116000270 120000270		0° - 180° - 270°	160 200	3395001249 3395001258	658,00 655,00
116090225 120090225		0° - 90° - 180° - 225°	160 200	3395003144 3395003145	679,00 655,00
116090270 120090270		0° - 90° - 180° - 270°	160 200	3395001251 3395001260	679,00 456,50
116135225 120135225		0° - 135° - 180° - 225°	160 200	3395003146 3395003147	679,00 456,50
116135270 120135270		0° - 135° - 180° - 270°	160 200	3395003148 3395003149	679,00 698,00

PP ŠACHTOVÉ DNÁ PRO1000

Objednávaci kód			Priemer napojenia	Objednávaci SAP kód	Cena EUR/ks
125000090		0° - 90° resp. 0° - 270°	250	3395001262	522,50
131000090			315	3395001281	544,50
140000090			400	3395001340	872,30
125000105		0° - 105° resp. 0° - 255°	250	3395003150	668,30
131000105			315	3395001284	695,30
140000105			400	3395001341	872,30
125000120		0° - 120° resp. 0° - 240°	250	3395003151	668,30
131000120			315	3395003152	695,30
140000120			400	3395003153	872,30
125000135		0° - 135° resp. 0° - 225°	250	3395001263	668,30
131000135			315	3395001288	695,30
140000135			400	3395001344	872,30
125000150		0° - 150° resp. 0° - 210°	250	3395001265	668,30
131000150			315	3395001290	695,30
140000150			400	3395001345	872,30
125000165		0° - 165° resp. 0° - 195°	250	3395001266	668,30
131000165			315	3395001296	695,30
140000165			400	3395001348	872,30
125000180		0° - 180°	250	3395001267	489,50
131000180			315	3395001299	508,20
140000180			400	3395001350	528,00
125091827		0° - 90° - 180° - 270°	250	3395001275	522,50
131091827			315	3395001317	544,50
140091827			400	3395001363	779,00
125091800		0° - 90° - 180°	250	3395001274	688,00
131091800			315	3395001316	544,50
140091800			400	3395001362	779,00
125001827		0° - 180° - 270°	250	3395001272	688,00
131001827			315	3395001310	544,50
140001827			400	3395001357	779,00
125131822		0° - 135° - 180° - 225°	250	3395001278	712,80
131131822			315	3395003154	762,00
125131800		0° - 135° - 180°	250	3395001277	668,30
131131800			315	3395003155	762,00
125001822		0° - 180° - 225°	250	3395003156	668,30
131001822			315	3395003157	762,00
116000001		Koncové dno	160	3395003158	365,00
120000001			200	3395003159	364,50
125000001			250	3395001261	378,00
131000001			315	3395001279	391,50
140000001			400	3395001339	465,00
100000000		Slepé dno		3395001245	354,00

Ceny sú bez DPH

Cenník platný od 1.6.2026

PP ID PRAGMA SN8, SN10, SN12 a SN16

Objednávaci kód	SN 8	Tyče dĺžka m	Vonkajší priemer	Vnútorný priemer	Objednávaci SAP kód	Cena EUR/ks
ID PR200/6		6	226,0	200	3395000071	82,60
ID PR250/6		6	284,0	250	3395000073	122,70
ID PR300/6		6	343,2	300	3395000075	159,00
ID PR400/6		6	457,8	400	3395000078	266,70
ID PR500/6		6	573,0	500	3395000083	441,30
ID PR600/6		6	688,0	600	3395000088	662,90
ID PR800/6		6	925,0	800	3395000092	1 245,60
ID PR1000/6		6	1 142,0	1 000	3395000069	1 823,60

Objednávaci kód	SN 10	Tyče dĺžka m	Vonkajší priemer	Vnútorný priemer	Objednávaci SAP kód	Cena EUR/ks
ID PR200/6 SN10		6	226,0	200	3395000072	85,00
ID PR250/6 SN10		6	284,0	250	3395000074	125,00
ID PR300/6 SN10		6	343,2	300	3395000076	164,00
ID PR400/6 SN10		6	457,8	400	3395000079	274,00
ID PR500/6 SN10		6	573,0	500	3395000084	458,00
ID PR600/6 SN10		6	688,0	600	3395000089	672,00
ID PR800/6 SN10		6	919,0	800	3395000093	1 272,00
ID PR1000/6 SN10		6	1 142,0	1 000	3395000070	1 868,00









Objednávaci kód	SN 12	Tyče dĺžka m	Vonkajší priemer	Vnútorný priemer	Objednávaci SAP kód	Cena EUR/ks
ID PR200/6 SN12		6	226,0	200	3395002981	94,00
ID PR250/6 SN12		6	284,0	250	3395003183	158,00
ID PR300/6 SN12		6	343,2	300	3395000077	192,00
ID PR400/6 SN12		6	457,8	400	3395000080	336,00
ID PR500/6 SN12		6	573,0	500	3395000085	513,00
ID PR600/6 SN12		6	688,0	600	3395000090	760,00
ID PR800/6 SN12		6	919,0	800	3395003188	1 327,00
ID PR1000/6 SN12		6	1 142,0	1 000	3395003180	2 105,00

Objednávaci kód	SN 16	Tyče dĺžka m	Vonkajší priemer	Vnútorný priemer	Objednávaci SAP kód	Cena EUR/ks
ID PR200/6 SN16		6	226,0	200	3395003182	133,00
ID PR250/6 SN16		6	284,0	250	3395003184	202,00
ID PR300/6 SN16		6	343,2	300	3395003185	236,00
ID PR400/6 SN16		6	457,8	400	3395000081	430,00
ID PR500/6 SN16		6	573,0	500	3395003186	645,00
ID PR600/6 SN16		6	688,0	600	3395003187	973,00
ID PR800/6 SN16		6	919,0	800	3395003189	1 826,00
ID PR1000/6 SN16		6	1 142,0	1 000	3395003181	2 723,00







































Objednávaci kód	SN 8	Tyče dĺžka m	Vonkajší priemer	Vnútorný priemer	Objednávaci kód	Cena EUR/ks
ID PR1200/6	NOVINIKA	6	1 356,0	1 200	3395003190	tel.
ID PR1400/6		6	1 583,0	1 400	3395003191	tel.

Poznámka: TESNENIE DN1200 A DN1400 NIE JE SÚČASŤOU RÚRY A JE POTREBNÉ HO DOOBJEDNAŤ









PP KORUGOVANÝ SYSTÉM SN8 - SN16

Objednávaci kód			Objednávaci SAP kód	Cena EUR/ks
ID PRB200/15	OBLÚK DN 200 dvojhrdlový bez tesnenia ID PRK200		3395000718	13,90
ID PRB200/30			3395000719	13,00
ID PRB200/45			3395000720	13,00
ID PRB200/90			3395000721	15,30
ID PRB250/15	OBLÚK DN 250 dvojhrdlový bez tesnenia ID PRK250		3395000722	23,90
ID PRB250/30			3395000723	25,90
ID PRB250/45			3395000724	23,90
ID PRB250/90			3395000725	25,90
ID PRB300/15	OBLÚK		3395000727	63,80
ID PRB300/30			3395000728	68,00
ID PRB300/45			3395000729	76,00
ID PRB300/90			3395000730	107,00
ID PRB400/15	OBLÚK		3395000731	99,00
ID PRB400/30			3395000732	106,00
ID PRB400/45			3395000733	128,00
ID PRB400/90			3395002892	175,00
ID PRB500/15	OBLÚK		3395000734	136,00
ID PRB500/30			3395000736	141,00
ID PRB500/45			3395002893	147,00
ID PRB500/90			3395000737	203,00
ID PRB600/15	OBLÚK		3395000738	243,00
ID PRB600/30			3395000739	251,00
ID PRB600/45			3395000740	329,00
ID PRB600/90			3395000742	388,00
ID PRB800/15	OBLÚK		3395002894	657,00
ID PRB800/30			3395000743	717,00
ID PRB800/45			3395002895	817,00
ID PRB800/90			3395000744	906,00
ID PRB1000/15	OBLÚK		3395002890	1256,00
ID PRB1000/30			3395000716	1258,00
ID PRB1000/45			3395000717	1260,00
ID PRB1000/90			3395002891	1261,00

PP KORUGOVANÝ SYSTÉM SN8 - SN16

Objednávaci kód	ODBOČKA 45°/45	Všetky odbočky sa vyrábajú aj s uhlom 87°	Objednávaci SAP kód	Cena EUR/ks
IDEAKG200/160/45		Na oboch stranách odbočky hrdlo ID PRAGMA DN200 (bez tesnenia) / odbočenie KG hrdlo D160	3395000796	25,50
IDEAKG200/200/45		Na oboch stranách odbočky hrdlo ID PRAGMA DN200 (bez tesnenia) / odbočenie KG hrdlo D200	3395000745	25,80
IDEAKG250/160/45		Na oboch stranách odbočky hrdlo ID PRAGMA DN250 (bez tesnenia) / odbočenie KG hrdlo D160	3395000799	44,30
IDEAKG250/200/45		Na oboch stranách odbočky hrdlo ID PRAGMA DN250 (bez tesnenia) / odbočenie KG hrdlo D200	3395000903	58,70
IDEAKG250/250/45		Hlavná vetva ID hrdlo DN250 a korug. koniec s tesnením / odbočenie hladký koniec D250	IDEAKG250/250/45	110,00
IDEAKG300/160/45		Na oboch stranách odbočky hrdlo ID PRAGMA DN300 (bez tesnenia) / odbočenie KG hrdlo D160	3395000803	155,00
IDEAKG300/200/45		Na oboch stranách odbočky hrdlo ID PRAGMA DN300 (bez tesnenia) / odbočenie KG hrdlo D160	3395004021	172,00
IDEAKG300/250/45		Hlavná vetva ID hrdlo DN300 a korug. koniec s tesnením / odbočenie hladký koniec D250	3395004060	216,00
IDEAKG300/300/45		Hlavná vetva ID hrdlo DN300 a korug. koniec s tesnením / odbočenie hladký koniec D315	3395004754	288,00
IDEAKG400/160/45		Hlavná vetva ID hrdlo DN400 a korug. koniec s tesnením / odbočenie hladký koniec D160	3395000808	197,00
IDEAKG400/200/45		Hlavná vetva ID hrdlo DN400 a korug. koniec s tesnením / odbočenie hladký koniec D200	3395004018	211,00
IDEAKG400/250/45		Hlavná vetva ID hrdlo DN400 a korug. koniec s tesnením / odbočenie hladký koniec D250	3395004220	299,00
IDEAKG400/315/45		Hlavná vetva ID hrdlo DN400 a korug. koniec s tesnením / odbočenie hladký koniec D315	3395003878	330,00
IDEAKG400/400/45		Hlavná vetva ID hrdlo DN400 a korug. koniec s tesnením / odbočenie hladký koniec D400	IDEAKG400/400/45	505,00
IDEAKG500/160/45		Hlavná vetva ID hrdlo DN500 a korug. koniec s tesnením / odbočenie hladký koniec D160	3395000784	268,00
IDEAKG500/200/45		Hlavná vetva ID hrdlo DN500 a korug. koniec s tesnením / odbočenie hladký koniec D200	3395000814	304,00
IDEAKG500/250/45		Hlavná vetva ID hrdlo DN500 a korug. koniec s tesnením / odbočenie hladký koniec D250	3395000785	340,00
IDEAKG500/315/45		Hlavná vetva ID hrdlo DN500 a korug. koniec s tesnením / odbočenie hladký koniec D315	3395003004	402,00
IDEAKG500/400/45		Hlavná vetva ID hrdlo DN500 a korug. koniec s tesnením / odbočenie hladký koniec D400	IDEAKG500/400/45	546,00
IDEAKG500/500/45		Hlavná vetva ID hrdlo DN500 a korug. koniec s tesnením / odbočenie hladký koniec D500	IDEAKG500/500/45	814,00
IDEAKG600/160/45		Hlavná vetva ID hrdlo DN600 a korug. koniec s tesnením / odbočenie hladký koniec D160	3395000820	402,00
IDEAKG600/200/45		Hlavná vetva ID hrdlo DN600 a korug. koniec s tesnením / odbočenie hladký koniec D200	3395004020	422,00
IDEAKG600/250/45		Hlavná vetva ID hrdlo DN600 a korug. koniec s tesnením / odbočenie hladký koniec D250	IDEAKG600/250/45	474,00
IDEAKG600/315/45		Hlavná vetva ID hrdlo DN600 a korug. koniec s tesnením / odbočenie hladký koniec D315	IDEAKG600/315/45	536,00
IDEAKG600/400/45		Hlavná vetva ID hrdlo DN600 a korug. koniec s tesnením / odbočenie hladký koniec D400	IDEAKG600/400/45	690,00
IDEAKG600/500/45		Hlavná vetva ID hrdlo DN600 a korug. koniec s tesnením / odbočenie hladký koniec D500	IDEAKG600/500/45	916,00
IDEAKG800/160/45		Hlavná vetva ID hrdlo DN800 a korug. koniec s tesnením / odbočenie hladký koniec D160	3395000826	742,00
IDEAKG800/200/45		Hlavná vetva ID hrdlo DN800 a korug. koniec s tesnením / odbočenie hladký koniec D200	3395000827	752,00
IDEAKG800/250/45		Hlavná vetva ID hrdlo DN800 a korug. koniec s tesnením / odbočenie hladký koniec D250	IDEAKG800/250/45	814,00
IDEAKG800/315/45		Hlavná vetva ID hrdlo DN800 a korug. koniec s tesnením / odbočenie hladký koniec D315	IDEAKG800/315/45	917,00
IDEAKG800/400/45		Hlavná vetva ID hrdlo DN800 a korug. koniec s tesnením / odbočenie hladký koniec D400	IDEAKG800/400/45	1092,00
IDEAKG800/500/45		Hlavná vetva ID hrdlo DN800 a korug. koniec s tesnením / odbočenie hladký koniec D500	IDEAKG800/500/45	1318,00
IDEAKG1000/160/45		Hlavná vetva ID hrdlo DN1000 a korug. koniec s tesnením / odbočenie hladký koniec D160	3395002901	1020,00
IDEAKG1000/200/45		Hlavná vetva ID hrdlo DN1000 a korug. koniec s tesnením / odbočenie hladký koniec D200	IDEAKG1000/200/45	1051,00
IDEAKG1000/250/45		Hlavná vetva ID hrdlo DN1000 a korug. koniec s tesnením / odbočenie hladký koniec D250	IDEAKG1000/250/45	1154,00
IDEAKG1000/315/45		Hlavná vetva ID hrdlo DN1000 a korug. koniec s tesnením / odbočenie hladký koniec D315	IDEAKG1000/315/45	1257,00
IDEAKG1000/400/45		Hlavná vetva ID hrdlo DN1000 a korug. koniec s tesnením / odbočenie hladký koniec D400	IDEAKG1000/400/45	1432,00
IDEAKG1000/500/45		Hlavná vetva ID hrdlo DN1000 a korug. koniec s tesnením / odbočenie hladký koniec D500	IDEAKG1000/500/45	1710,00

PP KORUGOVANÝ SYSTÉM SN8 - SN16

Objednávaci kód	ODBOČKA 45°/45 ODBOČKA 87°/87	Všetky odbočky sa vyrábajú aj s uhlom 87° Cenníková cena je pre 87°odbočky rovnaká ako u 45°	Objednávaci SAP kód	Cena EUR/ks
IDEA200/200/45		Na oboch stranách odbočky hrdlo ID PRAGMA DN250 (bez tesnenia) / odbočenie ID hrdlo DN200	3395000797	25,80
IDEA250/200/45		Na oboch stranách odbočky hrdlo ID PRAGMA DN250 (bez tesnenia) / odbočenie ID hrdlo DN200	3395000800	58,70
IDEA250/250/45		Hlavná vetva ID hrdlo DN250 a korug. koniec s tesnením / odbočenie ID hrdlo DN250	3395000801	110,00
IDEA300/200/45		Hlavná vetva ID hrdlo DN300 a korug. koniec s tesnením / odbočenie ID hrdlo DN200	3395000805	172,00
IDEA300/250/45		Hlavná vetva ID hrdlo DN300 a korug. koniec s tesnením / odbočenie ID hrdlo DN250	3395002902	216,00
IDEA300/300/45		Hlavná vetva ID hrdlo DN300 a korug. koniec s tesnením / odbočenie ID hrdlo DN300	3395000807	288,00
IDEA400/200/45		Hlavná vetva ID hrdlo DN400 a korug. koniec s tesnením / odbočenie ID hrdlo DN200	3395000810	211,00
IDEA400/250/45		Hlavná vetva ID hrdlo DN400 a korug. koniec s tesnením / odbočenie ID hrdlo DN250	3395002904	299,00
IDEA400/315/45		Hlavná vetva ID hrdlo DN400 a korug. koniec s tesnením / odbočenie ID hrdlo DN300	3395002906	330,00
IDEA400/400/45		Hlavná vetva ID hrdlo DN400 a korug. koniec s tesnením / odbočenie ID hrdlo DN400	3395000812	505,00
IDEA500/200/45		Hlavná vetva ID hrdlo DN500 a korug. koniec s tesnením / odbočenie ID hrdlo DN200	3395003871	304,00
IDEA500/250/45		Hlavná vetva ID hrdlo DN500 a korug. koniec s tesnením / odbočenie ID hrdlo DN250	3395000815	340,00
IDEA500/315/45		Hlavná vetva ID hrdlo DN500 a korug. koniec s tesnením / odbočenie ID hrdlo DN300	3395000816	402,00
IDEA500/400/45		Hlavná vetva ID hrdlo DN500 a korug. koniec s tesnením / odbočenie ID hrdlo DN400	3395000818	546,00
IDEA500/500/45		Hlavná vetva ID hrdlo DN500 a korug. koniec s tesnením / odbočenie ID hrdlo DN500	3395002908	814,00
IDEA600/200/45		Hlavná vetva ID hrdlo DN600 a korug. koniec s tesnením / odbočenie ID hrdlo DN200	3395000821	422,00
IDEA600/250/45		Hlavná vetva ID hrdlo DN600 a korug. koniec s tesnením / odbočenie ID hrdlo DN250	3395002910	474,00
IDEA600/315/45		Hlavná vetva ID hrdlo DN600 a korug. koniec s tesnením / odbočenie ID hrdlo DN300	3395000822	536,00
IDEA600/400/45		Hlavná vetva ID hrdlo DN600 a korug. koniec s tesnením / odbočenie ID hrdlo DN400	3395000824	690,00
IDEA600/500/45		Hlavná vetva ID hrdlo DN600 a korug. koniec s tesnením / odbočenie ID hrdlo DN500	3395002909	916,00
IDEA600/600/45		Hlavná vetva ID hrdlo DN600 a korug. koniec s tesnením / odbočenie ID hrdlo DN600	3395000825	979,00
IDEA800/200/45		Hlavná vetva ID hrdlo DN800 a korug. koniec s tesnením / odbočenie ID hrdlo DN200	3395005262	752,00
IDEA800/250/45		Hlavná vetva ID hrdlo DN800 a korug. koniec s tesnením / odbočenie ID hrdlo DN250	IDEA800/250/45	814,00
IDEA800/315/45		Hlavná vetva ID hrdlo DN800 a korug. koniec s tesnením / odbočenie ID hrdlo DN300	3395000828	917,00
IDEA800/400/45		Hlavná vetva ID hrdlo DN800 a korug. koniec s tesnením / odbočenie ID hrdlo DN400	IDEA800/400/45	1092,00
IDEA800/500/45		Hlavná vetva ID hrdlo DN800 a korug. koniec s tesnením / odbočenie ID hrdlo DN500	IDEA800/500/45	1318,00
IDEA800/600/45		Hlavná vetva ID hrdlo DN800 a korug. koniec s tesnením / odbočenie ID hrdlo DN600	IDEA800/600/45	1432,00
IDEA800/800/45		Hlavná vetva ID hrdlo DN800 a korug. koniec s tesnením / odbočenie ID hrdlo DN800	IDEA800/800/45	1597,00
IDEA1000/200/45		Hlavná vetva ID hrdlo DN1000 a korug. koniec s tesnením / odbočenie ID hrdlo DN200	3395002900	1051,00
IDEA1000/250/45		Hlavná vetva ID hrdlo DN1000 a korug. koniec s tesnením / odbočenie ID hrdlo DN250	IDEA1000/250/45	1154,00
IDEA1000/315/45		Hlavná vetva ID hrdlo DN1000 a korug. koniec s tesnením / odbočenie ID hrdlo DN300	IDEA1000/315/45	1257,00
IDEA1000/400/45		Hlavná vetva ID hrdlo DN1000 a korug. koniec s tesnením / odbočenie ID hrdlo DN400	IDEA1000/400/45	1432,00
IDEA1000/500/45		Hlavná vetva ID hrdlo DN1000 a korug. koniec s tesnením / odbočenie ID hrdlo DN500	IDEA1000/500/45	1710,00
IDEA1000/600/45		Hlavná vetva ID hrdlo DN1000 a korug. koniec s tesnením / odbočenie ID hrdlo DN600	IDEA1000/600/45	1936,00
IDEA1000/800/45		Hlavná vetva ID hrdlo DN1000 a korug. koniec s tesnením / odbočenie ID hrdlo DN800	IDEA1000/800/45	2153,00
IDEA1000/1000/45		Hlavná vetva ID hrdlo DN1000 a korug. koniec s tesnením / odbočenie ID hrdlo DN1000	IDEA1000/1000/45	2462,00

PP KORUGOVANÝ SYSTÉM SN8 - SN16

Objednávaci kód		Objednávaci SAP kód	Cena EUR/ks
ID PRU200	OPRAVNÁ PRESUVKA	3395000777	10,00
ID PRU250	DODÁVA SA BEZ TESNENIA ID PRK	3395000778	16,00
ID PRU300		3395000779	17,90
ID PRU400		3395000780	29,90
ID PRU500		3395000781	42,20
ID PRU600		3395000782	61,80
ID PRU800		3395000783	161,70
ID PRU1000		3395000776	448,10

ID PRH200	SPOJKA SO ZARÁŽKOU	3395002896	10,00
ID PRH250	DODÁVA SA BEZ TESNENIA ID PRK	3395000746	16,00
ID PRH300		3395000747	17,90
ID PRH400		3395000748	29,90
ID PRH500		3395000749	42,20
ID PRH600		3395000750	61,80
ID PRH800		3395002897	161,70
ID PRH1000		3395002898	448,10

ID PRR250/200	REDUKCIA	3395000768	17,90
ID PRR300/200	DODÁVA SA BEZ TESNENIA ID PRK	3395000769	35,00
ID PRR300/250		3395000770	47,80
ID PRR400/300		3395000771	105,00
ID PRR500/300		3395003931	123,00
ID PRR500/400		3395000772	133,00
ID PRR600/400		3395002899	215,00
ID PRR600/500		3395000774	244,00
ID PRR800/500		3395003530	273,00
ID PRR800/600		3395000775	313,00
ID PRR1000/600		3395004052	469,00
ID PRR1000/800		3395004768	548,00

ID PRAM200	ŠACHTOVÝ PRECHOD	3395002889	11,90
ID PRAM250	DODÁVA SA BEZ TESNENIA ID PRK	3395000711	14,30
ID PRAM300		3395000712	11,90
ID PRAM400		3395002868	16,00
ID PRAM500		3395000713	27,90
ID PRAM600		3395000714	43,90
ID PRAM800		3395000715	71,70
ID PRAM1000		3395000710	239,00

ID PRP200	ADAPTÉR ID PRAGMA/KG HRDLO	3395000763	11,50
ID PRP250	PRECHOD DO KG HRDLA	3395000764	19,90
ID PRP300	DODÁVA SA BEZ TESNENIA ID PRK	3395000765	46,40
ID PRP400		3395000766	89,60
ID PRP500		3395000767	151,40

IDO200	PRECHOD Z DRIEKU ID PRAGMA+ NA DRIEK KG	3395000758	11,50
IDO250	DVOJHRDLOVÁ TVAROVKA	3395000759	19,90
IDO300	dodáva sa bez tesnenia ID PRK	3395004195	50,50
IDO400	tesnenie KG je vložené	3395004719	97,90

PP KORUGOVANÝ SYSTÉM SN8 - SN16

Objednávaci kód		Objednávaci SAP kód	Cena EUR/ks
ID PRM200	ZÁTKA 	3395000751	16,00
ID PRM250		3395000752	16,90
ID PRM300		3395000753	53,80
ID PRM400		3395000754	77,70
ID PRM500		3395000755	97,60
ID PRM600		3395000756	137,50
ID PRM800		3395000757	237,10
ID PRM1000		3395003997	376,00

ID	Objednávaci kód	Objednávaci SAP kód	Cena EUR/ks
ID PRK200	TESNENIE 	3395002210	3,90
ID PRK250		3395002211	6,50
ID PRK300		3395002212	11,50
ID PRK400		3395002213	17,90
ID PRK500		3395002214	29,50
ID PRK600		3395002215	35,50
ID PRK800		3395002216	78,00
ID PRK1000		3395002209	127,00
ID PRK1200		3395004281	tel.
ID PRK1400		ID PRK1400	tel.









Objednávaci kód	Popis	Objednávaci kód	Cena EUR/ks	
IDEAM250/160	Navrtávacia sedlová odbočka pre PP PRAGMA 	250/160	3395000893	64,00
IDEAM315/160		315/160	3395000894	73,00
IDEAM315/200		315/200	3395000895	219,00
IDEAM400/160		400/160	3395000896	83,00
IDEAM400/200		400/200	3395000788	241,00
IDEAM500/160		500/160	3395000897	155,00
IDEAM500/200		500/200	3395000789	247,00
IDEAM630/160		630/160	3395000898	247,00
IDEAM630/200		630/200	3395000790	247,00

IDEAMK160	UŤAHOVACÍ KLÚČ	3395000900	227,00
IDEAMV160	KORUNKOVÝ VRTÁK 160	3395000902	412,00

Objednávaci kód	Popis	Objednávaci kód	Cena EUR/ks
LG110	IN SITU MANŽETY PRE JEDNODUCHÉ A RÝCHLE PRIPOJENIE HLADKEJ KANALIZAČNEJ RÚRY 	3395000878	18,80
LG125		3395000879	71,70
LG160		3395000880	19,50
LG200		3395000881	22,70
LG250		3395000882	40,00
LG315		3395000883	43,90

VRTAK110	KORUNKOVÝ VRTÁK PRE IN SITU 	3395005091	395,00
VRTAK125		VRTAK125	401,00
VRTAK160		3395000925	417,00
VRTAK200		3395000926	418,00
VRTAK250		3395003977	429,00
VRTAK315		3395003978	434,00

RÚRY DN 160 - 500









Objednávaci kód	SN 8 (SN 10)	Tyče dĺžka m	Vonkajší priemer	Hrúbka steny mm	DN priemer	Hmotnosť kg/m	Objednávaci SAP kód	Cena EUR/ks
PP-SN10-110/1		1	110	3,8	100	1,4	3395002059	9,60
PP-SN10-110/3		3					3395002060	27,00
PP-SN10-110/6		6					3395002061	53,20
PP-SN10-125/1		1	125	4,3	125	1,8	3395002062	12,00
PP-SN10-125/3		3					3395002063	33,50
PP-SN10-125/6		6					3395002064	65,10
PP-SN10-160/1		1	160	5,4	150	2,9	3395002065	20,50
PP-SN10-160/3		3					3395002066	53,50
PP-SN10-160/6		6					3395002067	104,70
PP-SN10-200/1		1	200	6,8	200	4,6	3395002068	32,30
PP-SN10-200/3		3					3395002069	83,50
PP-SN10-200/6		6					3395002070	162,20
PP-SN10-250/1		1	250	8,6	250	7,3	3395002071	52,30
PP-SN10-250/3		3					3395002072	130,50
PP-SN10-250/6		6					3395002073	246,70
PP-SN10-315/1		1	315	10,7	300	11,4	3395002074	83,90
PP-SN10-315/3		3					3395002075	206,00
PP-SN10-315/6		6					3395002076	387,10
PP-SN10-400/1		1	400	13,5	400	18,3	3395002077	140,20
PP-SN10-400/3		3					3395002078	343,10
PP-SN10-400/6		6					3395002079	648,30
PP-SN10-500/1		1	500	16,8	500	28,4	3395004296	233,70
PP-SN10-500/3		3					3395004295	552,90
PP-SN10-500/6		6					3395002080	1 020,80

RÚRY DN 160 - 500

Objednávaci kód	SN 12					Objednávaci SAP kód	Cena EUR/ks
	Tyče dĺžka m	Vonkajší priemer	Hrúbka steny mm	DN priemer	Hmotnosť kg/m		
PP-SN12-160/1	1	160	6,3	150	2,9	3395002048	22,40
PP-SN12-160/3	3					3395002049	58,80
PP-SN12-160/6	6					3395002051	115,40
PP-SN12-200/1	1	200	7,9	200	4,5	3395002052	36,30
PP-SN12-200/3	3					3395002053	94,20
PP-SN12-200/6	6					3395002054	183,20
PP-SN12-250/1	1	250	9,5	250	6,8	3395002071	56,00
PP-SN12-250/3	3					3395002072	145,30
PP-SN12-250/6	6					3395002073	275,90
PP-SN12-315/1	1	315	12,0	300	10,8	3395002055	91,00
PP-SN12-315/3	3					3395002056	232,40
PP-SN12-315/6	6					3395002057	439,60
PP-SN12-400/1	1	400	15,2	400	17,3	3395002077	176,40
PP-SN12-400/3	3					3395002078	414,80
PP-SN12-400/6	6					3395002079	737,80
PP-SN12-500/1	1	500	19,0	500	27,2	3395004296	281,00
PP-SN12-500/3	3					3395004295	654,50
PP-SN12-500/6	6					3395002058	1167,20

Objednávaci kód	SN 16					Objednávaci kód	Cena EUR/ks
	Tyče dĺžka m	Vonkajší priemer	Hrúbka steny mm	DN priemer	Hmotnosť kg/m		
PP-SN16-160/1	1	160		150		3395004063	26,10
PP-SN16-160/3	3					PP-SN16-160/3	67,60
PP-SN16-160/6	6					3395002081	132,30
PP-SN16-200/1	1	200		200		3395004064	42,20
PP-SN16-200/3	3					3395004065	109,50
PP-SN16-200/6	6					3395002082	213,20
PP-SN16-250/1	1	250		250		PP-SN16-250/1	65,60
PP-SN16-250/3	3					PP-SN16-250/3	170,80
PP-SN16-250/6	6					3395003985	324,30
PP-SN16-315/1	1	315		300		PP-SN16-300/1	106,10
PP-SN16-315/3	3					PP-SN16-300/3	270,10
PP-SN16-315/6	6					3395003033	514,80
PP-SN16-400/1	1	400		400		PP-SN16-400/1	190,40
PP-SN16-400/3	3					PP-SN16-400/3	486,50
PP-SN16-400/6	6					3395003034	863,70
PP-SN16-500/1	1	500		500		PP-SN16-500/1	328,70
PP-SN16-500/3	3					PP-SN16-500/3	767,30
PP-SN16-500/6	6					3395003035	1366,60

TVAROVKY PRE PP MASTER

Objednávaci kód			Uhol	Objednávaci SAP kód	Cena EUR/ks
PP-KGB110/15	OBLÚK		15°	3395002083	3,20
PP-KGB110/30			30°	3395002084	3,30
PP-KGB110/45			45°	3395002085	2,60
PP-KGB110/87			87°	3395002086	3,60
PP-KGB125/15	OBLÚK		15°	3395002087	7,00
PP-KGB125/30			30°	3395002088	7,80
PP-KGB125/45			45°	3395002089	7,30
PP-KGB125/87			87°	3395002090	7,90
PP-KGB160/15	OBLÚK		15°	3395002091	6,50
PP-KGB160/30			30°	3395002092	6,90
PP-KGB160/45			45°	3395002093	7,90
PP-KGB160/87			87°	3395002094	8,60
PP-KGB200/15	OBLÚK		15°	3395002095	13,90
PP-KGB200/30			30°	3395002096	15,00
PP-KGB200/45			45°	3395002097	16,30
PP-KGB200/87			87°	3395002098	19,70
PP-KGB250/15	OBLÚK		15°	3395002099	35,90
PP-KGB250/30			30°	3395002100	44,40
PP-KGB250/45			45°	3395002101	63,80
PP-KGB250/87			87°	3395004091	105,90
PP-KGB315/15	OBLÚK		15°	3395002102	50,50
PP-KGB315/30			30°	3395002103	72,30
PP-KGB315/45			45°	3395002104	95,30
PP-KGB315/87			87°	3395003837	159,80
PP-KGB400/15	OBLÚK		15°	3395004035	101,00
PP-KGB400/30			30°	3395002980	136,80
PP-KGB400/45			45°	3395003299	169,50
PP-KGB400/87			87°	3395004318	279,50
PP-KGB500/15	OBLÚK		15°	3395003838	tel.
PP-KGB500/30			30°	3395003839	tel.
PP-KGB500/45			45°	3395003840	tel.
PP-KGB500/87			87°	3395003841	tel.

TVAROVKY PRE PP MASTER

Objednávaci kód		Objednávaci SAP kód	Cena EUR/ks
PP-KGEA110/110/45	ODBOČKA 45°	3395002105	7,60
PP-KGEA125/110/45		3395002106	10,50
PP-KGEA125/125/46		3395002107	12,40
PP-KGEA160/110/45	ODBOČKA 45°	3395002108	17,70
PP-KGEA160/125/45		3395002109	18,30
PP-KGEA160/160/45		3395002110	19,20
PP-KGEA200/110/45	ODBOČKA 45°	3395002111	23,40
PP-KGEA200/160/45		3395002112	25,80
PP-KGEA200/200/45		3395002113	62,60
PP-KGEA250/110/45	ODBOČKA 45°	3395002114	75,70
PP-KGEA250/160/45		3395002115	87,50
PP-KGEA250/200/45		3395002116	89,90
PP-KGEA250/250/45		3395002117	tel.
PP-KGEA315/110/45	ODBOČKA 45°	3395002118	111,80
PP-KGEA315/160/45		3395002119	125,20
PP-KGEA315/200/45		3395002120	127,40
PP-KGEA315/250/45		3395002121	141,50
PP-KGEA315/315/45		3395002122	tel.
PP-KGEA400/110/45	ODBOČKA 45°	3395004771	188,00
PP-KGEA400/160/45		3395002123	203,10
PP-KGEA400/200/45		3395003041	205,40
PP-KGEA400/250/45		3395002124	217,50
PP-KGEA400/315/45		3395004203	227,40
PP-KGEA400/400/45		3395004772	tel.
PP-KGEA500/160/45	ODBOČKA 45°	3395004297	513,30
PP-KGEA500/200/45		3395003380	541,80
PP-KGEA500/250/45		3395004773	566,40
PP-KGEA500/315/45		3395003804	617,30
PP-KGEA500/400/45		3395004000	706,90
PP-KGEA500/500/45		3395003999	tel.
PP-KGR160/110	REDUKCIA	3395002127	10,10
PP-KGR160/125		3395002128	11,10
PP-KGR200/160		3395002129	13,80
PP-KGR250/200		3395002130	74,30
PP-KGR315/250		3395002131	81,20
PP-KGR400/315		3395002132	114,70
PP-KGR500/400		3395003842	tel.
PP-KGU110	PRESUVKA	3395002137	3,40
PP-KGU125		3395002138	9,50
PP-KGU160		3395002139	11,30
PP-KGU200		3395002140	19,20
PP-KGU250		3395002141	31,90
PP-KGU315		3395002142	42,10
PP-KGU400		3395002143	88,10
PP-KGU500		3395002144	tel.

HDPE PE100 SDR17 PN10

HDPE PE100 RÚRY PRE TLAKOVÝ A PODTLAKOVÝ ROZVOD KANALIZÁCIE

RÚRY PN10 DN 40-225 mm

Objednávaci kód	Balenie m	Vonkajší priemer	Hrúbka steny mm	Vnútorný priemer	Hmotnosť kg/m	Počet ks na palete	Objednávaci SAP kód	Cena EUR/m
040C170/100K	100	40	2,4	35,2	0,3	návin	3395001005	1,55
050C170/100K	100	50	3,0	44,0	0,45	návin	3395001013	2,31
063C170/100K	100	63	3,8	55,4	0,72	návin	3395001023	3,72
075C170/100K	100	75	4,5	66,0	1	návin	3395001029	5,18
090C170/100K	100	90	5,4	79,2	1,46	návin	3395001037	7,17
110C170/100K	100	110	6,6	96,8	2,17	návin	3395001046	10,21
125C170/012K	12	125	7,4	110,2	2,76	34	3395001051	12,98
160C170/012K	12	160	9,5	141,0	4,52	20	3395001061	21,53
225C170/012K	12	225	13,4	198,2	8,93	14	3395003829	40,58

Poznámka: Priemery HDPE rúr 40 - 110 na vyžiadanie aj v tyčiach 6m alebo 12m

HDPE PE100 SDR11 PN16

HDPE PE100 RÚRY PRE TLAKOVÝ A PODTLAKOVÝ ROZVOD KANALIZÁCIE

RÚRY PN16 DN 40-225 mm

Objednávaci kód	Balenie m	Vonkajší priemer	Hrúbka steny mm	Vnútorný priemer	Hmotnosť kg/m	Počet ks na palete	Objednávaci kód	Cena EUR/m
040C110/100K	100	40	3,7	32,6	0,43	návin	3395001001	2,27
050C110/100K	100	50	4,6	40,8	0,67	návin	3395001009	3,47
063C110/100K	100	63	5,8	51,4	1,05	návin	3395001019	5,35
075C110/100K	100	75	6,8	61,4	1,47	návin	3395004002	7,25
090C110/100K	100	90	8,2	73,6	2,12	návin	3395003952	10,40
110C110/100K	100	110	10,0	90,0	3,14	návin	3395004135	15,35
125C110/012K	12	125	11,4	102,2	4,08	34	3395004793	19,67
160C110/012K	12	160	14,6	130,8	6,67	20	3395001058	34,61
225C110/012K	12	225	20,5	184,0	13,1	14	3395004299	61,49

Poznámka: Priemery HDPE rúr 40 - 110 na vyžiadanie aj v tyčiach 6m alebo 12m

AQUALINE RC1 SDR17 PN10

HDPE PE100 RC RÚRY PRE TLAKOVÝ ROZVOD KANALIZÁCIE URČENÉ PRE BEZOBYSPOVÉ TECHNOLOGIE

RÚRY PN 10 DN50 - 315 mm

Objednávaci kód	Balenie m	Vonkajší priemer	Hrúbka steny mm	Vnútorný priemer	Hmotnosť kg/m	Počet ks na palete	Objednávaci SAP kód	Cena EUR/m
SPK050030100	100	50	3,0	44,0	0,46	návin	3395150338	2,56
SPK063038100	100	63	3,8	55,4	0,73	návin	3395150336	4,05
SPK075045100	100	75	4,5	66,0	1,03	návin	3395150333	5,79
SPK090054100	100	90	5,4	79,2	1,47	návin	3395150329	8,15
SPK110066100	100	110	6,6	96,8	2,19	návin	3395150325	11,41
SPK125074012	12	125	7,4	110,2	2,79	34	3395150322	15,02
SPK160095012	12	160	9,5	141,0	4,57	20	3395150318	24,62
SPK225134012	12	225	13,4	198,2	9,03	14	3395150312	44,50
SPK250148012	12	250	14,8	221,2	11,1	6	3395004780	57,37
SPK280166012	12	280	16,6	246,8	13,9	1	3395004781	73,13
SPK315187012	12	315	18,7	277,6	17,6	1	3395150306	89,82

AQUALINE RC1 SDR11 PN16

RÚRY PN 16 DN40 - 315 mm

Objednávaci kód	Balenie m	Vonkajší priemer	Hrúbka steny mm	Vnútorný priemer	Hmotnosť kg/m	Počet ks na palete	Objednávaci kód	Cena EUR/m
SPK032030100	100	32	3		0,27	návin	3395004783	1,50
SPK040037100	100	40	3,7	32,6	0,43	návin	3395150339	2,38
SPK050046100	100	50	4,6	40,8	0,67	návin	3395150337	3,80
SPK063058100	100	63	5,8	51,4	1,05	návin	3395150335	5,92
SPK075068100	100	75	6,8	61,4	1,47	návin	3395150334	8,82
SPK090082100	100/12	90	8,2	73,6	2,12	34	3395150328	11,74
SPK110100100	100/12	110	10,0	90,0	3,16	20	3395150323	17,30
SPK125114012	12	125	11,4	102,2	4,07	34	3395150321	22,66
SPK160146012	12	160	14,6	130,8	6,66	20	3395150317	35,12
SPK225205012	12	225	20,5	184,0	13,2	14	3395150312	69,22
SPK250227012	12	250	22,7	221,2	16,3	6	3395004790	84,36
SPK280254012	12	280	25,4	246,8	20,5	1	3395004791	105,06
SPK315286012	12	315	28,6	277,6	25,9	1	3395150305	134,93

ROBUST AQUALINE RC SDR17 PN10

Objednávaci kód	RÚRY PN 10 DN50 - 355 mm	Role/Tyče dĺžka m	Vonkajší priemer	Hrúbka steny mm	Hmotnosť kg/m	Objednávaci kód	Cena EUR/m
RSDK050030100		100	50	3,0	0,46	3395003335	5,05
RSDK063038100		100	63	3,8	0,73	3395003337	8,65
RSDK075045100		100	75	4,5	1,03	3395003339	10,92
RSDK090054100		100/12	90	5,4	1,47	3395003342	12,98
RSDK110066100		100/12	110	6,6	2,19	3395003346	17,90
RSDK125074012		12	125	7,4	2,79	3395003349	22,44
RSDK160095012		12	160	9,5	4,57	3395000975	27,20
RSDK225134012		12	225	13,4	9,03	3395003358	34,01
RSDK250148012		12	250	14,8	11,1	3395004794	45,59
RSDK280166012		12	280	16,6	13,9	3395004795	54,50
RSDK315187012		12	315	18,7	17,6	3395003859	69,06
RSDK355211012		12	355	21,1	22,4	3395004796	124,89

ROBUST AQUALINE RC SDR11 PN16

Objednávaci kód	RÚRY PN 16 DN50 - 355 mm	Role/Tyče dĺžka m	Vonkajší priemer	Hrúbka steny mm	Hmotnosť kg/m	Objednávaci kód	Cena EUR/m
RSDK050046100		100	50	4,6	0,66	3395150502	5,93
RSDK063058100		100	63	5,8	1,04	3395150501	8,97
RSDK075068100		100	75	6,8	1,47	3395003340	12,21
RSDK090082100		100/12	90	8,2	2,12	3395003344	17,22
RSDK110100100		100/12	110	10,0	3,16	3395003348	23,58
RSDK125114012		12	125	11,4	4,07	3395003350	30,29
RSDK160146012		12	160	14,6	6,66	3395003353	46,76
RSDK225205012		12	225	20,5	13,2	3395003359	91,76
RSDK250227012		12	250	22,7	16,3	3395004797	112,27
RSDK280254012		12	280	25,4	20,5	3395004798	149,35
RSDK315286012		12	315	28,6	25,9	3395004799	172,01
RSDK355322012		12	355	32,2	32,9	3395004800	221,45







Objednávaci kód		Objednávaci kód	Cena EUR/ks
RPL	Lúpač ochrannej vrstvy	3395002826	262,65
RPL-BRIT	Náhradný brit/ostrie	RPL-BRIT	78,28
RPL-DRŽIAK	Náhradný držiak britu/rúčka	RPL-DRŽIAK	8,03

Materiál PE100 RC + ochranná vrstva z polypropylénu









Vďaka vysokej odolnosti proti poškodeniu nie je potrebné použiť piesok ako obsypový materiál, rúry sú vhodné na zaťahovanie priamo do zeme bezvýkopovou technológiou.

FLEXO DRENÁŽNE RÚRY

RÚRY DN 50-200

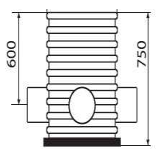
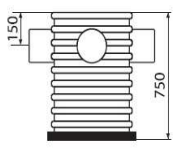
Objednávaci kód		Kotúče dĺžka m	Vonkajší priemer	Hmotnosť návinu kg	Priemer kotúča cm	Objednávaci SAP kód	Cena EUR/m
DXZ050	PERFORÁCIA 360° 	50	50	7	97	3395000207	1,16
DXZ065		50	65	10	105	3395000208	1,51
DXZ080		50	80	15,5	117	3395000209	1,72
DXZ100		50	100	21	128	3395000210	2,19
DXZ125		50	125,5	30,5	145	3395000211	3,69
DXZ160		50	159,5	49	190	3395000212	6,20
DXZ200		40	199,5	54	210	3395000213	10,14
DX050U	BEZ PERFORÁCIE 	50	50	7	97	3395000200	1,16
DX065U		50	65	10	105	3395000201	1,51
DX080U		50	80	15,5	117	3395000202	1,72
DX100U		50	100	21	128	3395000204	2,19
DX125U		50	125,5	30,5	145	3395000205	3,69
DX160U		50	159,5	49	190	3395000206	6,20
DX200U		40	199,5	54	210	3395004151	10,14
DX050GEO	OBALENÉ GEOTEXTÍLIU 	50	50	7	97	3395004104	1,58
DX065GEO		50	65	10	105	3395004105	2,08
DX080GEO		50	80	15,5	117	3395004106	2,49
DX100GEO		50	100	21	128	3395000203	3,00
DX125GEO		50	125,5	30,5	145	3395004107	4,96
DX160GEO		50	159,5	49	190	3395004085	7,58
DX200GEO		40	199,5	54	210	3395003970	11,90
Objednávaci kód	TVAROVKY PRE PVC DRENÁŽNE RÚRY					Objednávaci SAP kód	Cena EUR/ks
DXW80	KOLENO 					3395000869	4,88
DXW100						3395000870	7,49
DXW125						3395003369	11,86
DXW160						3395005228	25,40
DXB50/90	OBLÚK 					3395000830	2,99
DXB65/90						3395003962	5,46
DXB80/90						3395000831	7,42
DXB100/90						3395004194	14,11
DXEA065/065/45	ODBOČKA 45° 					3395000833	7,62
DXEA080/080/45						3395000834	8,45
DXEA100/100/45						3395000835	13,49
DXEA125/125/45						3395000836	16,17
DXEA160/160/45						3395003827	41,50
DXT050	T KUS 					3395000856	5,57
DXT065						3395000857	12,26
DXT080						3395000858	7,75
DXT100						3395000859	9,52
DXT125						3395000860	14,21
DXT160						3395000861	33,68
DXT200						3395003817	70,04
DXA160/80	REDUKOVANÝ T KUS					3395000469	22,04

TVAROVKY FLEXO DRENÁŽNE RÚRY

Objednávaci kód	TVAROVKY PRE PVC DRENÁŽNE RÚRY	Objednávaci SAP kód	Cena EUR/ks
DXU050	SPOJKA 	3395000862	0,72
DXU065		3395000863	1,29
DXU080		3395000864	1,35
DXU100		3395000865	1,23
DXU125		3395000866	4,49
DXU160		3395000867	5,55
DXU200		3395000868	19,26
DXR065/050	REDUKCIA 	3395000470	2,35
DXR080/065		3395000849	3,92
DXR100/080		3395000471	6,08
DXR125/100		3395000850	6,42
DXR160/125		3395000851	9,99
DXR200/160		3395000852	19,57
DXKLAP050	KLAPKA 	3395004809	9,68
DXKLAP065		3395000837	9,68
DXKLAP080		3395000838	10,40
DXKLAP100		3395000839	22,56
DXKLAP125		3395004810	32,96
DXKLAP160		3395000840	112,27
DXKLAP200		3395000841	67,98
DXM050	ZÁTKA 	3395000842	0,91
DXM065		3395003963	1,62
DXM080		3395000843	2,17
DXM100		3395000844	3,57
DXM125		3395000845	3,07
DXM160		3395000846	9,18
DRENÁŽNE ŠACHTY			
DXS300/100	ŠACHTOVÉ DNO BEZ LAPAČA PIESKU 	3395000853	158,62
DXS300/125		DXS300/125	251,32
DXS300/160		3395003828	229,69
DXSL300/100	ŠACHTOVÉ DNO S LAPAČOM PIESKU 	3395000854	158,62
DXSL300/125		3395003226	251,32
DXSL300/160		3395000855	229,69
DXSL300/200		3395003227	249,26
DXX300	SPOJKY 	3395000871	18,90
KGDOV315	Plastový pochôdzny poklop 1,5 t pre nový typ šachiet 315 na vlnovec 	3395001168	16,50
DXP300/0,5	PREDĽŽENIE ŠACHTY 	3395004932	15,97
DXP300/1		3395000847	30,80
DXP300/1,5		3395000848	47,17

PP ID PRAGMA DRENÁŽ SN8 - SN12

PP CESTNÁ DRENÁŽ S HLADKOU VNÚTORNOU STENOU SN8 - SN16 OBALENÁ GEOTEXTÍLIOU

RÚRY DN200 - 800 mm

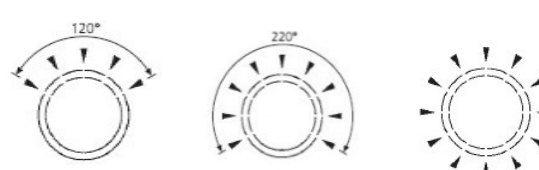
Objednávaci kód	SN8 TYP PERFORÁCIE 120° 220° 360°	Vonkajší priemer	Vnútorný priemer	Objednávaci kód	Cena SN8 EUR/ks
ID PR200/6D SN8		226,00	200	ID PR200/6D SN8	147,00
ID PR250/6D SN8		284,00	250	ID PR250/6D SN8	205,00
ID PR300/6D SN8		343,20	300	ID PR300/6D SN8	255,00
ID PR400/6D SN8		457,80	400	ID PR400/6D SN8	407,00
ID PR500/6D SN8		573,00	500	ID PR500/6D SN8	685,00
ID PR600/6D SN8		688,00	600	ID PR600/6D SN8	956,00
ID PR800/6D SN8		925,00	800	ID PR800/6D SN8	1720,00
ID PR1000/6D SN8		1142,00	1000	ID PR1000/6D SN8	2390,00

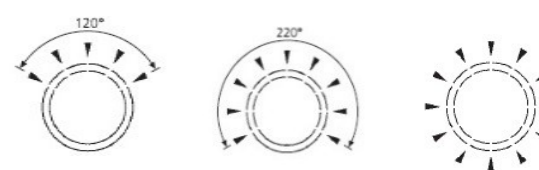
Objednávaci kód	SN10 TYP PERFORÁCIE 120° 220° 360°	Vonkajší priemer	Vnútorný priemer	Objednávaci kód	Cena SN10 EUR/ks
ID PR200/6D SN10		226,00	200	ID PR200/6D SN10	159,00
ID PR250/6D SN10		284,00	250	ID PR250/6D SN10	223,00
ID PR300/6D SN10		343,20	300	ID PR300/6D SN10	279,00
ID PR400/6D SN10		457,80	400	ID PR400/6D SN10	443,00
ID PR500/6D SN10		573,00	500	ID PR500/6D SN10	735,00
ID PR600/6D SN10		688,00	600	ID PR600/6D SN10	1020,00
ID PR800/6D SN10		925,00	800	ID PR800/6D SN10	1840,00
ID PR1000/6D SN10		1142,00	1000	ID PR1000/6D SN10	2590,00

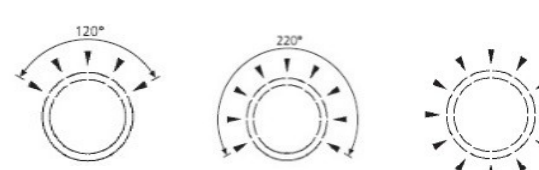
Objednávaci kód	SN12 TYP PERFORÁCIE 120° 220° 360°	Vonkajší priemer	Vnútorný priemer	Objednávaci kód	Cena SN12 EUR/ks
ID PR200/6D SN12		226,00	200	ID PR200/6D SN12	182,00
ID PR250/6D SN12		284,00	250	ID PR250/6D SN12	255,00
ID PR300/6D SN12		343,20	300	ID PR300/6D SN12	321,00
ID PR400/6D SN12		457,80	400	ID PR400/6D SN12	509,00
ID PR500/6D SN12		573,00	500	ID PR500/6D SN12	849,00
ID PR600/6D SN12		688,00	600	ID PR600/6D SN12	1175,00
ID PR800/6D SN12		925,00	800	ID PR800/6D SN12	2115,00
ID PR1000/6D SN12		1142,00	1000	ID PR1000/6D SN12	2890,00

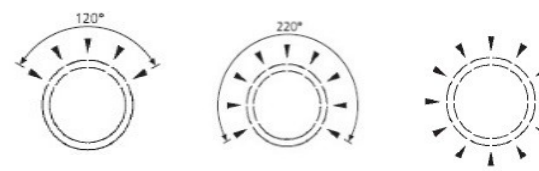
Objednávaci kód	SN16 TYP PERFORÁCIE 120° 220° 360°	Vonkajší priemer	Vnútorný priemer	Objednávaci kód	Cena SN16 EUR/ks
ID PR200/6D SN16		226,00	200	ID PR200/6D SN16	229,00
ID PR250/6D SN16		284,00	250	ID PR250/6D SN16	320,00
ID PR300/6D SN16		343,20	300	ID PR300/6D SN16	405,00
ID PR400/6D SN16		457,80	400	ID PR400/6D SN16	635,00
ID PR500/6D SN16		573,00	500	ID PR500/6D SN16	1059,00
ID PR600/6D SN16		688,00	600	ID PR600/6D SN16	1470,00
ID PR800/6D SN16		925,00	800	ID PR800/6D SN16	2650,00
ID PR1000/6D SN16		925,00	800	ID PR1000/6D SN16	3190,00

Sortiment tvaroviek ID PRAGMA cenník strana 24 - 28







RÚRY DN 110 - 400







Objednávaci kód		Tyče dĺžka m	Vonkajší priemer	Vnútorný priemer	Hmotnosť kg/m	Objednávaci SAP kód	Cena EUR/ks
PR110/6D	Bez perforácie, vrátane tesnenia  	6	110	95	0,97		51,50
PR160/6D		6	160	139	1,50	3497100286	57,70
PR200/6D		6	200	174	2,15	3497100315	95,80
PR250/6D		6	250	218	3,65	3497100384	150,40
PR315/6D		6	315	276	5,70	3497100403	198,80
PR400/6D	6	400	348	7,60	3497100426	318,30	

PR110/6D	Perforácia 120°, vrátane tesnenia  	6	110	95	0,97	3497101821	51,50
PR160/6D		6	160	139	1,50	3497100290	57,70
PR200/6D		6	200	174	2,15	3497100316	95,80
PR250/6D		6	250	218	3,65	3497100386	150,40
PR315/6D		6	315	276	5,70	3497100406	198,80
PR400/6D	6	400	348	7,60	3497100423	318,30	

PR110/6D	Perforácia 220°, vrátane tesnenia  	6	110	95	0,97	3497101822	51,50
PR160/6D		6	160	139	1,50	3497100291	57,70
PR200/6D		6	200	174	2,15	3497100317	95,80
PR250/6D		6	250	218	3,65	3497100387	150,40
PR315/6D		6	315	276	5,70	3497100407	198,80
PR400/6D	6	400	348	7,60	3497100424	318,30	

PR110/6D	Perforácia 360°, vrátane tesnenia  	6	110	95	0,97	3497101823	51,50
PR160/6D		6	160	139	1,50	3497100292	57,70
PR200/6D		6	200	174	2,15	3497100318	95,80
PR250/6D		6	250	218	3,65	3497100388	150,40
PR315/6D		6	315	276	5,70	3497100408	198,80
PR400/6D	6	400	348	7,60	3497100425	318,30	

Objednávaci kód	OD KORUGOVANÉ TVAROVKY PRE PP OD PRAGMA NIE SÚ PERFOROVANÉ	Uhol	Objednávaci SAP kód	Cena EUR/ks
PRB160/15	KOLENO 	15°	3395000884	13,30
PRB160/30		30°	3395000885	13,30
PRB160/45		45°	3395000886	13,60
PRB200/15	KOLENO	15°	3395004935	18,80
PRB200/30		30°	3395004310	20,00
PRB200/45		45°	3395004301	20,20
PRB200/90		87°	PRB200/90	84,80
PRB250/15	KOLENO 	15°	PRB250/15	41,10
PRB250/30		30°	PRB250/30	43,30
PRB250/45		45°	PRB250/45	45,00
PRB250/90		87°	PRB250/90	113,00
PRB315/15	KOLENO	15°	3395000887	62,90
PRB315/30		30°	3395000888	62,70
PRB315/45		45°	3395000889	62,70
PRB315/90		87°	3395004276	177,00
PRB400/15	KOLENO 	15°	PRB400/15	170,00
PRB400/30		30°	PRB400/30	185,00
PRB400/45		45°	PRB400/45	228,00
PRB400/90		87°	PRB400/90	275,00

Objednávaci kód		Objednávaci SAP kód	Cena EUR/ks
PREA160/160	ODBOČKA 45° Pri odbočení hladkou KG rúrou treba použiť spojovací komplet PRS	3395004727	30,80
PREA200/160		3395005127	31,90
PREA200/200		3395004302	38,20
PREA250/160		PREA250/160	64,10
PREA250/200		3395004309	67,20
PREA250/250		3395003303	226,00
PREA315/160		3395000890	81,00
PREA315/200		3395000891	69,00
PREA315/250		3395002872	170,00
PREA400/160		3395003230	265,00
PREA400/200		3395004728	274,00
PREA400/250		PREA400/250	319,00
PREA400/315		3395000892	380,00
			
PRU160	OPRAVNÁ PRESUVKA DN315-400 dodávané bez tesnenia PRK	3395000920	13,60
PRU200		3395000921	20,10
PRU250		3395004201	23,10
PRU315		3395000922	35,70
PRU400		3395000923	73,00
			
PRH160	SPOJKA SO ZARÁŽKOU DN315-400 dodávané bez tesnenia PRK	3395005089	13,60
PRH200		3395002896	20,10
PRH250		3395000746	23,10
PRH315		3395000747	35,70
PRH400		3395000904	73,00
			
PRR200/160	REDUKCIA	PRR200/160	20,60
PRR250/160		PRR250/160	56,70
PRR250/200		3395004349	77,70
PRR315/200		PRR315/200	83,00
PRR315/250		PRR315/250	78,80
PRR400/250		3395004190	93,50
PRR400/315	PRR400/315	99,80	
			
PRP160	PRECHOD DO HRDLA KG HLADKEJ RÚRY - ADAPTÉR	3395003378	11,00
PRP200		3395000910	17,50
PRP250		3395000764	34,60
PRP315		3395000911	52,10
PRP400		3395000912	97,60
			
PRS110	SPOJOVACÍ KOMPLET NA VYTVORENIE KG HRDLA Z HRDLA PRAGMY	3395005121	2,90
PRS200		3395000915	4,10
PRS200		3395000915	7,90
PRS250		3395000916	9,10
PRS315		3395000917	13,80
PRS400		3395000918	25,30
PRS500		3395000919	62,30
			
PRM160	ZÁTKA DO HRDLA	3395002979	13,20
PRM200		3395004920	18,10
PRM250		3395004920	37,60
PRM315		3395000908	92,70
PRM400		3395000909	121,00
			

STORMBOX VSAKOVACÍ SYSTÉM

RETENČNÉ A DETENČNÉ SYSTÉMY STORMBOX

Objednávaci kód	Rozmer mm	Celkový/využitelný objem (litre)	zamová účinnosť %	napojnosť horizontálne	napojnosť vertikálne	Objednávaci SAP kód	Cena EUR/ks
STORMBOX	1200x600x300	216/206	>95,5 %	N110,125,160	10, 125,160,	3395000873	48,00



STORMDNO						3395000874	18,00
----------	--	--	--	--	--	------------	-------



STORMKLIP	36x21,5					3395000875	0,20
-----------	---------	--	--	--	--	------------	------



Objednávaci kód	Gramáž g/m2	Objednávaci SAP kód	Cena EUR/m2
GEOTEXTILIA300	300	3395002818	2,50



Objednávaci kód	VSTUPNÝ ADAPTÉR	Objednávaci SAP kód	Cena EUR/ks
STORMADAPT250		STORMADAPT250	127,00
STORMADAPT315		3395000872	137,00
STORMADAPT400		STORMADAPT400	142,00
STORMADAPT500		STORMADAPT500	146,00



STORMBOX ŠACHTA 300

STORMSACHT300						3395000876	320,00
---------------	--	--	--	--	--	------------	--------

Objednávaci kód	Filtračné šachty	Priemer šachty mm	Napojenie D mm	Výška mm	Objednávaci SAP kód	Cena EUR/ks
-----------------	------------------	-------------------	----------------	----------	---------------------	-------------

FS300/160/1500		315	160	1500	FS300/150/1500	116,00
----------------	---	-----	-----	------	----------------	--------

FS400/160/1800		400	160-200	1500	3395001525	249,00
Bahenný kôš		400			3395002820	27,80
KGDOV400ID		400			3395004907	56,00









FS630/200/1500		630	160-200	1500	3395001528	550,00
FS630/200/2000		630	160-200	2000	3395001529	690,00
Bahenný kôš		400			3395002820	27,80

FS1000/200		1000	200	1800	3395001515	890,00
FS1000/250		1000	250	1800	3395003856	950,00
FS1000/315		1000	315	1800	3395001519	1250,00
FS1000/400		1000	400	1800	3395001521	1590,00

V prípade požiadavky kalkulujeme konkrétnu situáciu podľa Vami dodaných špecifikácií, množstvo zadrživanej vody, plocha odvádzania, max plocha pre osadenie boxov.

STORMBOX II VSAKOVACÍ SYSTÉM

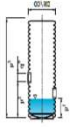
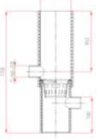
RETENČNÉ A DETENČNÉ SYSTÉMY STORMBOX II

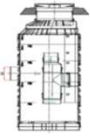
Objednávaci kód	Rozmer mm	Celkový/využitelný objem (litre)	Účinnosť %	Prírodnosť napojenia horizontálne	Prírodnosť napojenia vertikálne	Objednávaci SAP kód	Cena EUR/ks
STORMBOXII Základný box	1200x600x600 	432/412,6	95,50	160-400	200-630	3395004073	97,00
STORMDNOII Podkladová doska						3395004074	25,00
STORMBOKII Bočná platňa						3395004075	12,00
STORMPRIPII Bočná platňa s pripojením				160-400		3395004076	12,00
STORMBOX II adapter Adapter pre zvislé napojenie kontrolnej šachty, komín OD400 / 630					400-630	3395004280	118,00
STORMBOX II odvetranie Adapter pre zvislé napojenie odvetrávacej rúry D200					200,00	3395004278	95,00
Objednávaci kód	Gramáž g/m2					Objednávaci SAP kód	Cena EUR/m2
GEOTEXTILIA300						3395002818	2,50
Objednávaci kód	Filtračné šachty	Priemer šachty mm	Napojenie D mm	Výška mm	Objednávaci SAP kód	Cena EUR/ks	
FS300/160/1500		315	160	1500	FS300/150/1500	116,00	
FS400/160/1800		400	160-200	1500	3395001525	249,00	
Bahenný kôš		400			3395002820	27,80	
KGDOV400ID		400			3395004907	56,00	
FS630/200/1500		630	160-200	1500	3395001528	550,00	
FS630/200/2000		630	160-200	2000	3395001529	690,00	
Bahenný kôš		400			3395002820	27,80	
FS1000/200		1000	200	1800	3395001515	890,00	
FS1000/250		1000	250	1800	3395003856	950,00	
FS1000/315		1000	315	1800	3395001519	1250,00	
FS1000/400		1000	400	1800	3395001521	1590,00	

V prípade požiadavky kalkuluje konkrétnu situáciu podľa Vami dodaných špecifikácií, množstvo zadrživanej vody, plocha odvádzania, max plocha pre osadenie boxov.

HDPE PE100 SDR17 PN10

RÚRY PN 10 DN25 - 630 mm

Objednávaci kód	Role/Tyče dĺžka m	Vonkajší priemer	Hrúbka steny mm	Hmotnosť kg/m	Počet ks na palete	Objednávaci SAP kód	Cena EUR/m
025C170/100	100	25	1,8	0,14	návin	3395310005	0,89
032C170/100	100	32	1,9	0,19	návin	3395310010	1,01
040C170/100	100	40	2,4	0,30	návin	3395310014	1,55
050C170/100	100	50	3,0	0,45	návin	3395310019	2,31
063C170/100	100	63	3,8	0,72	návin	3395310029	3,72
075C170/100	100	75	4,5	1,00	návin	3395310035	5,18
090C170/100	100				návin	3395310043	7,17
090C170/006	6	90	5,4	1,46	58	3395310040	7,17
110C170/100	100				návin	3395310052	10,20
110C170/012	12	110	6,6	2,19	48	3395310050	10,20
125C170/006	6				34	3395310056	13,00
125C170/012	12	125	7,4	2,76	34	3395310057	13,00
140C170/006	6				40	3395001053	16,70
140C170/012	12	140	8,3	3,50	40	3395001054	16,70
160C170/006	6				20	3395310061	21,50
160C170/012	12	160	9,5	4,52	20	3395310062	21,50
180C170/012	12	180	10,7	5,77	24	3395001064	26,20
200C170/012	12	200	11,9	7,10	15	3395310067	34,00
225C170/012	12	225	13,4	9,03	14	3395310071	40,60
250C170/012	12	250	14,8	11,10	12	3395310075	51,30
280C170/012	12	280	16,6	13,90	12	3395310077	64,90
315C170/012	12	315	18,7	17,20	6	3395310081	79,30
355C170/012	12	355	21,1	22,40	1	3395310085	105,00
400C170/012	12	400	23,7	28,90	1	3395310087	137,00
450C170/012	12	450	26,7	36,60	1	3395310089	173,00
500C170/012	12	500	29,7	45,10	1	3395310091	215,00



Poznámka: Priemery HDPE rúr 40 - 110 na vyžiadanie aj v tyčiach 6m alebo 12m

HDPE PE100 SDR11 PN16

Objednávaci kód	Role/Tyče dĺžka m	Vonkajší priemer	Hrúbka steny mm	Hmotnosť kg/m	Počet ks na palete	Objednávaci SAP kód	Cena EUR/m
025C110/100	100	25	2,3	0,17	návin	3395310002	0,92
032C110/100	100	32	2,9	0,27	návin	3395310008	1,47
040C110/100	100	40	3,7	0,43	návin	3395310012	2,27
050C110/100	100	50	4,6	0,67	návin	3395310016	3,47
063C110/100	100	63	5,8	1,05	návin	3395310024	5,35
075C110/100	100	75	6,8	1,47	návin	3395310032	7,25
090C110/100	100				návin	3395310039	10,40
090C110/012	12	90	8,2	2,12	58	3395310037	10,40
110C110/100	100				návin	3395310047	15,40
110C110/012	12	110	10,0	3,16	48	3395310046	15,40
125C110/006	6				34	3395310054	19,70
125C110/012	12	125	11,4	4,08	34	3395310055	19,70
140C110/006	6				40		27,80
140C110/012	12	140	12,7	5,11	40	3395001052	27,80
160C110/006	6				20	3395310058	34,60
160C110/012	12	160	14,6	6,67	20	3395310059	34,60
180C110/012	12	180	16,4	8,43	24	3395001063	41,30
200C110/012	12	200	18,2	10,40	15	3395310065	49,50
225C110/012	12	225	20,5	13,10	14	3395310069	61,50
250C110/012	12	250	22,7	16,20	12	3395310073	74,20
280C110/012	12	280	25,4	20,40	12	3395310076	95,80
315C110/012	12	315	28,6	25,80	6	3395310079	121,00
355C110/012	12	355	32,2	32,70		3395310083	154,00
400C110/012	12	400	36,3	42,20		3395004040	tel.



AQUALINE RC1 SDR17 PN10

RÚRY PN 10 DN32 - 500 mm

Objednávaci kód	Plnostenné rúry RC, 100% čierna	Role/Tyče dĺžka m	Vonkajší priemer	Hrúbka steny mm	Hmotnosť kg/m	Objednávaci SAP kód	Cena EUR/m
SPW050030100		100/12	50	3	0,45	3395150273	2,56
SPW063038100		100/12	63	3,8	0,72	3395150268	4,05
SPW075045100		100/12	75	4,5	1,02	3395150261	5,79
SPW090054100		100/12	90	5,4	1,47	3395150254	8,15
SPW110066100		100/12	110	6,6	2,18	3395150247	11,41
SPW125074012		12	125	7,4	2,79	3395150241	15,02
SPW140083012		12	140	8,3	3,50	3395150234	18,85
SPW160095012		12	160	9,5	4,57	3395150227	24,62
SPW180107012		12	180	10,7	5,77	3395150222	31,21
SPW200119012		12	200	11,9	7,12	3395150219	37,60
SPW225134012		12	225	13,4	9,03	3395150215	44,50
SPW250148012		12	250	14,8	11,10	3395150212	57,37
SPW280166012		12	280	16,6	13,90	3395150209	73,13
SPW315187012		12	315	18,7	17,60	3395150207	89,82
SPW355211012		12	355	21,1	22,40	3395150205	119,48
SPW400237012		12	400	23,7	28,30	3395150202	145,23
SPW450267012		12	450	26,7	36,60	SPW450267012	tel.
SPW500297012		12	500	29,7	45,10	SPW500297012	tel.

AQUALINE RC1 SDR11 PN16

RÚRY PN 16 DN32 - 400 mm

Objednávaci kód	Plnostenné rúry RC, 100% čierna	Role/Tyče dĺžka m	Vonkajší priemer	Hrúbka steny mm	Hmotnosť kg/m	Objednávaci SAP kód	Cena EUR/m
SPW032030100		100/12	32	2,9	0,28	3395150278	1,50
SPW040037100		100/12	40	3,7	0,43	3395150275	2,38
SPW050046100		100/12	50	4,6	0,67	3395150271	3,80
SPW063058100		100/12	63	5,8	1,06	3395150265	5,92
SPW075068100		100/12	75	6,8	1,48	3395150258	8,82
SPW090082100		100/12	90	8,2	2,14	3395150251	11,74
SPW110100100		100/12	110	10,0	3,18	3395150244	17,30
SPW125114012		12	125	11,4	4,12	3395150238	22,66
SPW140127012		12	140	12,7	5,13	3395150231	28,02
SPW160146012		12	160	14,6	6,74	3395150225	35,12
SPW180164012		12	180	16,4	8,52	3395150221	43,98
SPW200182012		12	200	18,2	10,5	3395150218	54,69
SPW225205012		12	225	20,5	13,3	3395150213	69,22
SPW250227012		12	250	22,7	16,35	3395150211	84,36
SPW280254012		12	280	25,4	20,5	3395150208	105,06
SPW315286012		12	315	28,6	25,95	3395150206	134,93
SPW355322012		12	355	32,2	32,94	3395150204	168,92
SPW400363012		12	400	36,3	41,82	3395150201	211,15
SPW450409012		12	450	40,9	53,62	SPW450409012	tel.

Materiál PE100 RC

Vďaka vysokej odolnosti proti poškodeniu nie je potrebné použiť piesok ako obsypový materiál, prípadne použitie pre šetrné bezvýkopové technológie ako pluhovanie, relining a pod.

AQUALINE RC2 SDR17 PN10

RÚRY PN 10 DN32 - 500 mm

Objednávaci kód	Plnostenné rúry RC, 90% čierna 10% modrá	Role/Tyče dĺžka m	Vonkajší priemer	Hrúbka steny mm	Hmotnosť kg/m	Objednávaci SAP kód	Cena EUR/m
STW050030100		100	50	3	0,45	3395003294	2,61
STW063038100		100	63	3,8	0,72	3395003527	4,13
STW075045100		100	75	4,5	1,00	3395003287	5,90
STW090054100		100	90	5,4	1,47	3395000954	8,31
STW090054012		12	90	5,4	1,47	3395000953	8,31
STW110066100		100	110	6,6	2,19	3395000960	11,63
STW110066012		12	110	6,6	2,19	3395000962	11,63
STW125074012		12	125	7,4	2,79	3395003172	15,31
STW140083012		12	140	8,3	3,50	3395003039	19,22
STW160095012		12	160	9,5	4,57	3395000966	25,10
STW180107012		12	180	10,7	5,77	3395000968	31,82
STW200119012		12	200	11,9	7,12	3395003177	38,33
STW225134012		12	225	13,4	9,03	3395000970	45,36
STW250148012		12	250	14,8	11,10	3395004066	58,49
STW280166012		12	280	16,6	13,90	3395000973	74,55
STW315187012		12	315	18,7	17,60	3395003031	91,56
STW355211012		12	355	21,1	22,40	3395002982	121,80
STW400237012		12	400	23,7	28,30	3395000974	148,05
STW450267012		12	450	26,7	36,60	3395004846	tel.
STW500297012		12	500	29,7	45,10	3395003974	tel.

AQUALINE RC2 SDR11 PN16

RÚRY PN 16 DN32 - 400 mm

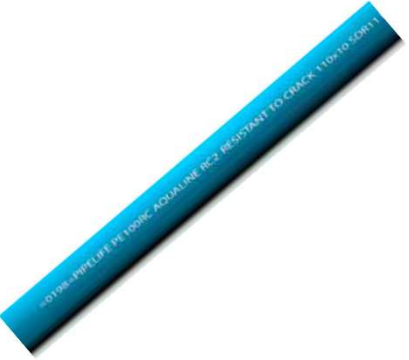
Objednávaci kód	Plnostenné rúry RC, 90% čierna 10% modrá	Role/Tyče dĺžka m	Vonkajší priemer	Hrúbka steny mm	Hmotnosť kg/m	Objednávaci SAP kód	Cena EUR/m
STW032029100		100	32	2,9	0,27	3395003290	1,53
STW040037100		100	40	3,7	0,43	3395003292	2,43
STW050046100		100	50	4,6	0,67	3395003296	3,87
STW063058100		100	63	5,8	1,05	3395003844	6,04
STW075068100		100	75	6,8	1,47	3395003322	8,99
STW090082100		100	90	8,2	2,12	3395000957	11,97
STW090082012		12	90	8,2	2,12	3395000956	11,97
STW110100100		100	110	10,0	3,16	3395000963	17,64
STW110100012		12	110	10,0	3,16	3395000962	17,64
STW125114012		12	125	11,4	4,07	3395003174	23,10
STW140127012		12	140	12,7	5,13	3395003179	28,56
STW160146012		12	160	14,6	6,66	3395000967	35,81
STW180164012		12	180	16,4	8,51	3395003176	44,84
STW200182012		12	200	18,2	10,5	3395003178	55,76
STW225205012		12	225	20,5	13,2	3395000972	70,56
STW250227012		12	250	22,7	16,3	3395003880	86,00
STW280254012		12	280	25,4	20,5	3395003881	107,10
STW315286012		12	315	28,6	25,9	3395000951	137,55
STW355322012		12	355	32,2	32,9	3395003973	172,20
STW400363012		12	400	36,3	41,7	3395003965	215,25
STW450409012		12	450	40,9	53,60	3395004847	tel.
STW500454012		12	500	45,4	66,20	3395004205	tel.

Materiál PE100 RC

Vďaka vysokej odolnosti proti poškodeniu nie je potrebné použiť piesok ako obsypový materiál, prípadne použitie pre šetrné bezvýkopové technológie ako pluhovanie, relining a pod.

ROBUST AQUALINE RC2 SDR17 PN10

RÚRY PN 10 DN50 - 400 mm

Objednávaci kód	V návíne vyrábané bez vyhľadávacieho vodiča	Role/Tyče dĺžka m	Vonkajší priemer	Hrúbka steny mm	Hmotnosť kg/m	Objednávaci SAP kód	Cena EUR/m
RSDW050030100		100	50	3,0	0,46	3395003245	5,05
RSDW063038100		100	63	3,8	0,73	3395000977	8,65
RSDW075045100		100	75	4,5	1,03	3395003246	10,92
RSDW090054100		100	90	5,4	1,47	3395000978	12,98
RSDW090054012		12	90	5,4	1,47	3395003247	12,98
RSDW110066100		100	110	6,6	2,19	3395003248	17,90
RSDW110066012		12	110	6,6	2,19	3395000979	17,90
RSDW125074012		12	125	7,4	2,79	3395003249	22,44
RSDW140083012		12	140	8,3	3,50	3395003250	27,20
RSDW160095012		12	160	9,5	4,57	3395003251	34,01
RSDW180107012		12	180	10,7	5,77	3395003252	45,59
RSDW200119012		12	200	11,9	7,12	3395003253	54,50
RSDW225134012		12	225	13,4	9,03	3395000981	69,06
RSDW250148012		12	250	14,8	11,10	3395003254	81,15
RSDW280166012		12	280	16,6	13,90	3395003255	99,21
RSDW315187012		12	315	18,7	17,60	3395003256	124,89
RSDW355211012		12	355	21,1	22,40	3395003257	160,71
RSDW400237012		12	400	23,7	28,30	3395003258	tel.

ROBUST AQUALINE RC2 SDR11 PN16

RÚRY PN 16 DN50 - 400 mm

Objednávaci kód		Role/Tyče dĺžka m	Vonkajší priemer	Hrúbka steny mm	Hmotnosť kg/m	Objednávaci SAP kód	Cena EUR/m
RSDW050046100		100	50	4,6	0,66	3395000976	5,93
RSDW063058100		100	63	5,8	1,04	3395003259	8,97
RSDW075068100		100	75	6,8	1,47	3395003260	12,21
RSDW090082100		100	90	8,2	2,12	3395003261	17,22
RSDW090082012		12	90	8,2	2,12	3395003262	17,22
RSDW110100100		100	110	10,0	3,16	3395000980	23,58
RSDW110100012		12	110	10,0	3,16	3395003037	23,58
RSDW125114012		12	125	11,4	4,07	3395003263	30,29
RSDW140127012		12	140	12,7	5,13	3395003264	36,87
RSDW160146012		12	160	14,6	6,66	3395003265	46,76
RSDW180164012		12	180	16,4	8,51	3395003266	59,95
RSDW200182012		12	200	18,2	10,50	3395003267	74,78
RSDW225205012		12	225	20,5	13,2	3395003268	91,67
RSDW250227012		12	250	22,7	16,30	3395003269	112,27
RSDW280254012		12	280	25,4	20,50	3395003270	149,35
RSDW315286012		12	315	28,6	25,90	3395003032	172,01
RSDW355322012		12	355	32,2	32,90	3395003271	221,45
RSDW400363012		12	400	36,3	41,70	3395003272	tel.

Objednávaci kód		Objednávaci kód	Cena EUR/ks
RPL	Lúpač ochrannej vrstvy	3395002826	262,65
RPL-BRIT	Náhradný brit/ostrie	RPL-BRIT	78,28
RPL-DRŽIAK	Náhradný držiak britu/rúčka	RPL-DRŽIAK	8,03



Materiál PE100 RC + ochranná vrstva z polypropylénu

Vďaka vysokej odolnosti proti poškodeniu nie je potrebné použiť piesok ako obsypový materiál, rúry sú vhodné na zaťahovanie priamo do zeme bezvýkopovou technológiou.

PVC-U TLAKOVÝ SYSTÉM

RÚRY PN 6, 0,6 MPa, 6 bar







Objednávaci kód	Tyče dĺžka m	Vonkajší priemer	Hrúbka steny mm	Hmotnosť kg/m	Počet ks na palete	Objednávaci SAP kód	Cena EUR/ks
KM090/6M6B	6	90	2,7	1,16	100	KM090/6M6B	36,00
KM110/6M6B	6	110	2,7	1,68	64	KM110/6M6B	39,70
KM160/6M6B	6	160	4,0	3,56	42	KM160/6M6B	84,00
KM225/6M6B	6	225	5,5	5,98	16	KM225/6M6B	158,00
KM280/6M6B	6	280	6,9	10,97	16	KM280/6M6B	266,00
KM315/6M6B	6	315	7,7	13,87	9	KM315/6M6B	335,00

RÚRY PN 10, 1,0 MPa, 10 bar

Objednávaci kód	Tyče dĺžka m	Vonkajší priemer	Hrúbka steny mm	Hmotnosť kg/m	Počet ks na palete	Objednávaci SAP kód	Cena EUR/ks
KM090/6M10B	6	90	4,3	1,62	48	3395000148	52,00
KM110/6M10B	6	110	4,2	1,95	40	3395000149	59,00
KM160/6M10B	6	160	6,2	4,19	42	3395000150	124,00
KM225/6M10B	6	225	8,6	8,18	20	3395000151	238,00
KM280/6M10B	6	280	10,7	11,26	16	3395003882	389,00
KM315/6M10B	6	315	12,1	16,11	9	3395000152	495,00
KM450/6M10B	6	450	17,4	37,65		KM450/6M10B	1025,00

PVC-U TLAKOVÝ SYSTÉM

TVAROVKY PN 10, 1,0 MPa, 10 bar

Objednávaci kód		Objednávaci SAP kód	Cena EUR/ks
UKS090	PRESUVKA 	3395000464	9,96
UKS110		3395000465	12,70
UKS160		3395000466	26,80
UKS225		3395000467	54,00
UKS280		3395004147	97,00
UKS315		3395000468	128,00
MKKS090/11	OBLÚK 	3395000449	12,10
MKKS090/22		3395004311	13,00
MKKS090/30		3395004312	13,80
MKKS090/45		3395004274	14,70
MKKS110/11	OBLÚK 	3395000450	17,50
MKKS110/22		3395000451	18,00
MKKS110/30		3395000452	19,50
MKKS110/45		3395000453	21,50
MKKS160/11	OBLÚK 	3395003845	35,00
MKKS160/22		3395000454	37,00
MKKS160/30		3395000455	41,00
MKKS160/45		3395000456	45,00
MKKS225/11	OBLÚK 	3395004127	159,00
MKKS225/22		3395004128	142,00
MKKS225/30		3395000457	154,00
MKKS225/45		3395004129	177,00
MKKS280/11	OBLÚK 	MKKS280/11	252,00
MKKS280/22		MKKS280/22	276,00
MKKS280/30		MKKS280/30	296,00
MKKS280/45		MKKS280/45	347,00
MKKS315/11	OBLÚK 	3395000458	322,00
MKKS315/22		3395004406	368,00
MKKS315/30		MKKS315/30	392,00
MKKS315/45		3395000459	462,00
MQKS090/ 90	OBLÚK 90° 	3395000460	21,60
MQKS110/ 90		3395000461	29,80
MQKS160/ 90		3395000462	69,70
MQKS225/ 90		3395004214	253,00
MQKS280/ 90		3395004215	472,00
MQKS315/ 90		3395004216	659,00
MRKS110/080	REDUKCIA 	3395002991	32,60
MRKS225/160		3395002994	97,00
MRKS280/225		3395002995	143,00
MRKS315/280		3395002996	154,00

GASLINE RC2

Objednávaci kód	SDR 11	Role/Tyče dĺžka m	Vonkajší priemer	Hrúbka steny mm	Hmotnosť kg/m	Objednávaci kód	Cena EUR/m
STG025030100	Plnostenná rúra RC, 90% čierna 10% oranžová	100	25	2,3	0,17	3395003235	1,58
STG032030100	Plnostenná rúra RC, 90% čierna 10% oranžová	100	32	3,0	0,27	3395001149	1,78
STG040037100	Plnostenná rúra RC, 90% čierna 10% oranžová	100	40	3,7	0,42	3395001150	2,78
STG050046100	Plnostenná rúra RC, 90% čierna 10% oranžová	100	50	4,6	0,66	3395001151	4,32
STG063058100	Plnostenná rúra RC, 90% čierna 10% oranžová	100	63	5,8	1,04	3395001153	6,54

SDR 17

STG090054012	Plnostenná rúra RC, 90% čierna 10% oranžová	12	90	6,4	1,40	3395005245	8,44
STG090054100	Plnostenná rúra RC, 90% čierna 10% oranžová	100	90	6,4	1,40	3395005246	8,44
STG110066012	Plnostenná rúra RC, 90% čierna 10% oranžová	12	110	6,6	2,10	3395005248	13,74
STG110066100	Plnostenná rúra RC, 90% čierna 10% oranžová	100	110	6,6	2,10	3395005250	13,74
STG160095012	Plnostenná rúra RC, 90% čierna 10% oranžová	12	160	9,5	4,40	3395005252	26,20
STG225134012	Plnostenná rúra RC, 90% čierna 10% oranžová	12	225	13,4	8,64	3395005254	50,20
STG315187012	Plnostenná rúra RC, 90% čierna 10% oranžová	12	315	18,7	16,9	3395005256	93,00

Všetky rúry je možné objednať v 6 alebo 12 m tyčiach

HDPE PE100 RC RÚRY PRE TLAKOVÝ ROZVOD PLYNU S OCHRANNOU VRSTVOU Z PP URČENÉ PRE BEZVÝKOPOVÉ TECHNOLOGIE
ROBUST GASLINE RC2

Objednávaci kód	SDR 11	Role/Tyče dĺžka m	Vonkajší priemer	Hrúbka steny mm	Hmotnosť kg/m	Počet ks na palete	Objednávaci kód	Cena EUR/m
RPDG025030100		100	25	3,0	0,21	návin	RPDG025030100+	tel.
RPDG032030100		100	32	3,0	0,27	návin	1596200691	tel.
RPDG040037100		100	40	3,7	0,45	návin	1596200693	tel.
RPDG050046100		100	50	4,6	0,67	návin	1596200695	tel.
RPDG063058100		100	63	5,8	1,06	návin	1596200697	tel.







SDR 17

RPDG090054100		100	90	5,4	1,4	48	1596200216	tel.
RPDG110066100		12	110	6,6	2,1	43	1596200207	tel.
RPDG160095012		12	160	9,5	4,4		1596200208	tel.
RPDG225134012		12	225	13,4	8,64	17	1596200210	tel.
RPDG315187012		12	315	18,7	16,9	11	1596200592	tel.

RPL	Lúpač ochrannej vrstvy		3395002826	262,65
RPL-BRIT	Náhradný brit/ostrie		RPL-BRIT	76,00
RPL-DRŽIAK	Náhradný držiak britu/rúčka		RPL-DRŽIAK	7,80

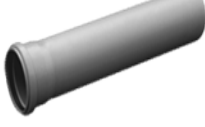
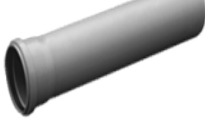
Poznámka: Priemery HDPE rúr d25 - 110 na vyžiadanie aj v tyčiach 12m

RÚRY DN 32 - 150 mm











Objednávaci kód		Balenie Zásobník/paleta	Objednávaci SAP kód	Cena EUR/ks
HT032/0150		110/2640	3395001703	0,62
HT032/0250		30/1440	3395001704	0,72
HT032/0500		105/1260	3395001705	1,02
HT032/1000		20/720	3395001706	1,91
HT032/1500		20/720	3395001707	2,56
HT032/2000		20/720	3395001708	3,31
HT040/0150		70/1680	3395001709	0,71
HT040/0250		50/1200	3395001710	0,87
HT040/0500		60/720	3395001711	1,13
HT040/1000		20/400	3395001712	1,82
HT040/1500		20/400	3395001713	2,64
HT040/2000		20/400	3395001714	3,44
HT050/0150		20/800	3395001716	0,80
HT050/0250		15/600	3395001717	1,00
HT050/0500		20/360	3395001718	1,31
HT050/1000		20/240	3395001719	2,00
HT050/1500		20/240	3395001720	2,98
HT050/2000		20/240	3395001721	3,69
HT075/0150		20/360	3395001722	1,13
HT075/0250		20/360	3395001723	1,39
HT075/0500		30/180	3395001724	1,87
HT075/1000		10/140	3395001725	3,10
HT075/1500		10/140	3395001726	4,44
HT075/2000		10/140	3395001727	5,66
HT110/0150		10/180	3395001728	2,00
HT110/0250		10/180	3395001729	2,38
HT110/0500		15/90	3395001730	3,67
HT110/1000		10/60	3395001731	5,98
HT110/1500		10/60	3395001732	8,78
HT110/2000		10/60	3395001733	11,50
HT125/0250		20/120	3395001735	4,99
HT125/0500		6/48	3395001736	6,97
HT125/1000		6/48	3395001737	12,10
HT125/2000		6/48	3395001739	19,00
HT160/0250		12/72	3395001741	8,87
HT160/0500		5/40	3395001742	12,00
HT160/1000		6/30	3395001743	19,30
HT160/2000		6/30	3395001745	32,20

Objednávaci kód		Balenie Zásobník/paleta	Objednávaci SAP kód	Cena EUR/ks
HTGL040/5000	HT rúra bez hrdla 	5/2000	3395320850	8,28
HTGL050/5000		5/1200	3395320851	10,90
HTGL075/5000		5/700	3395320852	16,90
HTGL110/5000		5/300	3395320853	31,10
HTGL125/5000		5/240	3395320854	60,00
HTGL160/5000		5/30	3395320855	204,00

PP HT VNÚTORNÝ ODPAD

POPLYPROPYLÉNOVÉ HT TVAROVKY PRE BEZTLAKOVÝ ROZVOD VNÚTORNEHO ODPADU











TVAROVKY DN 32 - 160 mm

Objednávaci kód		Balenie Zásobník/paleta	Objednávaci SAP kód	Cena EUR/ks
HTMM032	DVOJITÉ HRDLO 	60/2880	3395001974	1,00
HTMM040		30/1440	3395001975	1,01
HTMM050		25/1200	3395001976	1,02
HTMM075		25/600	3395001977	2,20
HTMM110		25/600	3395001978	2,19
HTMM125		8/160	3395001979	8,96
HTMM160	5/80	3395001980	13,90	
HTU032	PRESUVNÉ HRDLO 	60/2880	3395002022	0,75
HTU040		30/1440	3395002023	0,93
HTU050		25/1200	3395002024	1,08
HTU075		20/640	3395002025	1,28
HTU110		30/384	3395002026	2,08
HTU125		20/160	3395002027	8,43
HTU160	10/80	3395002028	13,80	
HTL040	PREDĽŽENÉ HRDLO 	20/1280	3395001962	2,38
HTL050		40/640	3395001963	2,27
HTL075		20/320	3395001964	3,89
HTL110		20/240	3395001965	5,72
HTL125		20/160	3395001966	34,70
HTNH110	NÁSTRČNÉ HRDLO 	1/9	3395001981	6,08
HTRPVC050/063	ADAPTÉR PVC/PP HT 	30/3960	3395002007	2,62
HTRPVC063/075		18/2376	3395002008	3,84
HTB032/15	KOLENO 	15° 60/3360	3395001836	0,58
HTB032/30		30° 70/3360	3395001837	0,58
HTB032/45		45° 70/3360	3395001838	0,58
HTB032/67		67° 70/3360	3395001839	0,58
HTB032/87		87° 70/3360	3395001840	0,58
HTB040/15	KOLENO 	15° 40/1920	3395001841	0,60
HTB040/30		30° 40/32000	3395001842	0,60
HTB040/45		45° 40/1920	3395001843	0,60
HTB040/67		67° 40/1920	3395001844	0,60
HTB040/87		87° 40/1600	3395001845	0,60
HTB050/15	KOLENO 	15° 80/1920	3395001846	0,58
HTB050/30		30° 70/1680	3395001847	0,58
HTB050/45		45° 40/1200	3395001848	0,58
HTB050/67		67° 25/1200	3395001849	0,58
HTB050/87		87° 40/1200	3395001850	0,58
HTB075/15	KOLENO 	15° 25/600	3395001851	1,26
HTB075/30		30° 25/600	3395001852	1,15
HTB075/45		45° 25/600	3395001853	1,15
HTB075/67		67° 20/480	3395001854	1,15
HTB075/87		87° 30/1200	3395001855	1,15
HTB110/15	KOLENO 	15° 30/240	3395001856	1,72
HTB110/30		30° 30/240	3395001857	1,72
HTB110/45		45° 25/200	3395001858	1,72
HTB110/67		67° 25/200	3395001859	1,94
HTB110/87		87° 25/200	3395001860	1,94







PP HT VNÚTORNÝ ODPAD

POPLYPROPYLÉNOVÉ HT TVAROVKY PRE BEZTLAKOVÝ ROZVOD VNÚTORNEHO ODPADU

TVAROVKY DN 32 - 160 mm

Objednávaci kód			Uhol	Balenie ks/obrázok/paleta	Objednávaci SAP kód	Cena EUR/ks
HTB125/15	KOLENO		15°	25/200	3395001861	3,21
HTB125/30			30°	20/160	3395001862	3,21
HTB125/45			45°	20/120	3395001863	3,21
HTB125/67			67°	10/160	3395001864	11,60
HTB125/87			87°	15/120	3395001865	4,59
HTB160/15	KOLENO		15°	10/80	3395001866	12,50
HTB160/30			30°	10/80	3395001867	14,10
HTB160/45			45°	10/80	3395001868	8,04
HTB160/87			87°	8/64	3395001869	9,18
HTBO040	OBLÚK 90°		90°	10/200	3395003228	2,00
HTBO050			90°	10/200	3395003229	2,42
HTBD040/040/87	DVOJITÉ KOLENO 87°		87°	10	3395005174	4,85
HTBD050/050/87			87°	10	3395005175	4,85
HTBD110/110/87			87°	10	3395004344	31,60
HTBLA110/040	KOLENO S ODBOČKOU		30°	20/160	3395001871	11,50
HTBLA110/050	VĽAVO		30°	20/160	3395001872	11,90
HTBPA110/040	KOLENO S ODBOČKOU		30°	20/160	3395001875	12,20
HTBPA110/050	VPRAVO		30°	20/160	3395001876	12,20
HTBDA110/040	KOLENO S ODBOČKOU		30°	20/160	3395001435	14,70
HTBDA110/050	DVOJITÉ		30°	20/160	3395001870	16,50
HTBOA110/040	KOLENO S ODBOČKOU			20/160	3395001873	12,10
HTBOA110/050	OSOVÉ			20/160	3395001874	12,10
HTSO110/040	SEDLOVÁ ODBOČKA			18/180	3395002014	16,80
HTSO110/050				18/180	3395002015	16,80
HTSO125/040				18/180	3395002921	22,10
HTSO125/050				18/180	3395002016	22,10
HTSVOR	VRTÁK PRE ODBOČKU			1	3395002017	12,40
HTEA032/032/45	ODBOČKA 45°			70/1680	3395001898	1,18
HTEA040/040/45				50/1200	3395001900	1,16
HTEA050/040/45				20/640	3395001903	1,20
HTEA050/050/45				20/600	3395001906	1,23
HTEA075/050/45				25/300	3395001912	1,97
HTEA075/075/45				20/240	3395001915	2,08
HTEA110/050/45				25/200	3395001921	2,65
HTEA110/075/45				15/120	3395001924	3,59
HTEA110/110/45				20/120	3395001927	3,59
HTEA125/110/45				10/80	3395001930	5,24
HTEA125/125/45				10/80	3395001933	5,95
HTEA160/110/45				10/60	3395001936	16,20
HTEA160/125/45				10/60	3395001938	19,60
HTEA160/160/45				4/32	3395001941	8,74









TVAROVKY DN 32 - 150 mm

Objednávaci kód		Balenie Zásobník/paleta	Objednávaci SAP kód	Cena EUR/ks
HTEA040/040/67	ODBOČKA 67° 	20/1280	3395001901	1,18
HTEA050/040/67		20/640	3395001904	1,20
HTEA050/050/67		20/640	3395001907	1,26
HTEA075/050/67		25/300	3395001913	1,97
HTEA075/075/67		20/240	3395001916	2,45
HTEA110/050/67		20/240	3395001922	2,68
HTEA110/075/67		20/160	3395001925	3,59
HTEA110/110/67		12/96	3395001928	3,59
HTEA160/110/67		10/60	3395002919	40,00
HTEA160/125/67		10/60	3395001939	64,00
HTEA160/160/67	5/40	3395001942	92,00	
HTEA032/032/87	ODBOČKA 87° 	70/1680	3395001899	1,18
HTEA040/040/87		25/1200	3395001902	1,16
HTEA050/040/87		25/2100	3395001905	1,16
HTEA050/050/87		35/840	3395001908	1,16
HTEA075/050/87		25/300	3395001914	1,93
HTEA075/075/87		25/300	3395001917	2,45
HTEA110/050/87		25/200	3395001923	2,77
HTEA110/075/87		20/160	3395001926	3,59
HTEA110/110/87		15/120	3395001929	3,25
HTEA125/110/87		10/80	3395001932	10,40
HTEA125/125/87		20/160	3395001935	11,80
HTEA160/110/87		10/60	3395001937	16,30
HTEA160/125/87		20/40	3395001940	18,60
HTEA160/160/87	5/40	3395001943	16,50	
HTDA050/050/45	DVOJITÁ ODBOČKA 45° 	10/480	3395001879	9,26
HTDA075/050/45		10/180	3395001882	12,10
HTDA075/075/45		20/800	3395001884	14,70
HTDA110/040/45		20/160	3395001887	22,10
HTDA110/050/45		10/160	3395001888	8,53
HTDA110/075/45		10/80	3395001891	17,10
HTDA110/110/45		8/64	3395001894	8,55
HTDA050/050/67	DVOJITÁ ODBOČKA 67° 	10/320	3395001880	10,60
HTDA075/075/67		20/160	3395001885	12,60
HTDA110/050/67		10/160	3395001889	17,10
HTDA110/075/67		20/120	3395001892	19,00
HTDA110/110/67		5/80	3395001895	22,10
HTDA050/050/87	DVOJITÁ ODBOČKA 87° 	10/840	3395001881	9,51
HTDA075/050/87		10/240	3395001883	10,60
HTDA075/075/87		20/160	3395001886	14,70
HTDA110/050/87		10/160	3395001890	14,70
HTDA110/075/87		10/200	3395001893	17,90
HTDA110/110/87		10/80	3395001896	18,40
HTED050/050/45	DVOJITÁ ROHOVÁ ODBOČKA 45°, 67°, 87° 	10/840	HTED050/050/45	15,00
HTED050/050/67		10/840	3395001944	16,70
HTED075/075/67		10/400	3395001945	17,80
HTED110/050/45		8/320	3395004103	17,90
HTED110/050/67		10/80	3395001946	17,90
HTED110/110/45		10/160	HTED110/110/45	28,40
HTED110/110/67		10/80	3395001947	41,10
HTED110/110/87		20/80	3395001948	29,50

PP HT VNÚTORNÝ ODPAD

POPLYPROPYLÉNOVÉ HT TVAROVKY PRE BEZTLAKOVÝ ROZVOD VNÚTORNEHO ODPADU

TVAROVKY DN 32 - 160 mm

Objednávaci kód		Balenie Zásobník/paleta	Objednávaci SAP kód	Cena EUR/ks
HTEP110/075/67L	DVOJITÁ PANELÁKOVÁ ODBOČKA 	10/80	3395001957	23,20
HTEP110/075/67P		10/80	3395001958	23,20
HTEP110/075/87L		10/80	3395001959	23,20
HTEP110/075/87P		10/80	3395001960	23,20
HTEK110/050/67L	DVOJITÁ PANELÁKOVÁ ODBOČKA KRÁTKA 	10/80	3395001949	12,10
HTEK110/050/67P		10/80	3395001950	12,10
HTEK110/050/87L		10/80	3395001951	13,80
HTEK110/050/87P		10/80	3395001952	13,80
HTEK110/075/67L		10/80	3395001953	15,10
HTEK110/075/67P		10/80	3395001954	15,10
HTEK110/075/87L		10/80	3395002920	12,50
HTEK110/075/87P		10/80	3395003852	15,10
HTR040/032	REDUKCIA 	20/5280	3395001983	0,60
HTR050/032		100/2800	3395001985	0,63
HTR050/040		35/4620	3395001986	0,61
HTR075/040		30/2520	3395001988	1,22
HTR075/050		35/840	3395001990	1,22
HTR110/040		20/1680	3395001992	1,56
HTR110/050		20/480	3395001994	1,56
HTR110/075		20/480	3395001996	1,32
HTR125/110		20/320	3395001998	4,11
HTR160/110		20/160	3395001999	4,32
HTR160/125		20/240	3395002000	5,05
HTR040/032K		KRÁTKA REDUKCIA 	50/3600	3395001984
HTR050/040K	50/6600		3395001987	1,31
HTR075/040K	20/2640		3395001989	1,77
HTR075/050K	20/2640		3395001991	1,82
HTR110/040K	20/1680		3395001993	2,33
HTR110/050K	20/640		3395001995	1,88
HTR110/075K	20/1680		3395001997	2,52
HTRV075/050	VNÚTORNÁ REDUKCIA 	10/240	3395002009	7,72
HTRV110/050		10/200	3395002010	5,68
HTRV110/075		10/200	3395002011	5,89
HTRV125/110		1/10	3395003371	6,28
HTRV160/050		1	3395003372	20,00
HTRV160/110		1	3395002012	20,00
HTRS032/040	REDUKCIA OBRÁTENÁ 	20/5280	3395003233	1,23
HTRS040/050		20/2640	3395003234	1,44
HTUG050	PRECHOD Z LIATINY DO PP-HT HRDLA (treba doobjednať tesnenie GA) 	20/2640	3395002029	1,86
HTUG075		20/1680	3395002030	1,94
HTUG110		50/900	3395002031	2,86
HTGA50	TESNENIE PRE PRECHOD Z PP DO LIATINY 	1/50	3295392002	1,45
HTGA75		1/30	3295393001	1,57
KAME110		1/20	3395000472	2,25

TVAROVKY DN 32 - 160 mm

Objednávaci kód			Balenie Zásobník/paleta	Objednávaci SAP kód	Cena EUR/ks
HTRE050	ČISTIACI KUS		20/640	3395002001	2,36
HTRE075			25/450	3395002002	3,52
HTRE110			8/192	3395002003	4,26
HTRE125			20/240	3395002004	9,68
HTRE160			10/80	3395002005	27,40

HTREB110	KOLENO-ČISTIACI KUS		12/96	3395002006	5,16
----------	---------------------	---	-------	------------	------

Objednávaci kód			Balenie	Objednávaci SAP kód	Cena EUR/ks
HTM032	HRDLOVÁ ZÁTKA		280/20160	3395001967	0,29
HTM040			170/8160	3395001968	0,29
HTM050			90/4320	3395001969	0,41
HTM075			50/2400	3395001970	0,60
HTM110			50/1200	3395001971	0,68
HTM125			100/800	3395001972	1,58
HTM160			50/400	3395001973	2,53

Objednávaci kód			Balenie	Objednávaci SAP kód	Cena EUR/ks
HTS040/040	PRIPOJOVACÍ KUS PRIAMY		20/1280	3395003163	1,12
HTS050/040			20/2560	3395002013	1,16
HTS050/050			20/1280	3395003162	1,68

Objednávaci kód			Balenie	Objednávaci SAP kód	Cena EUR/ks
HTSW040/032	PRIPOJOVACIE KOLENO		50/1600	3395002018	1,94
HTSW040/040			50/1600	3395002019	1,06
HTSW050/040			50/1200	3395002020	1,22
HTSW050/050			50/1600	3395002021	1,83
HTDSW050/050/050	DVOJITÉ PRIPOJOVACIE KOLENO		20/480	3395004086	4,18

GUMENÁ MANŽETA PRE HTS, HTSW, HTDSW

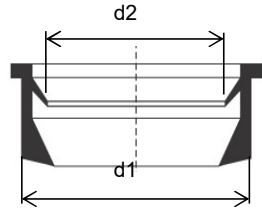





Objednávaci kód		d1		d2	Balenie	Objednávaci SAP kód	Cena EUR/ks
GM046/20-32		46		20-32	50/500	3395320991	0,90
GM046/040		46		40	50/500	3395001832	0,76
GM040/20-26		40		20-26	50/500	3395320990	0,66
GM040/26-32		40		26-32	50/500	3395001831	0,70
GM050/20-26		50		20-36	50/500	3395003003	1,04
GM050/26-32		50		26-32	50/500	3395001833	1,05
GM050/32-40		50		32-40	50/500	3395001834	0,98
GM060/26-32		60		26-32	20/500	3395003972	1,75
GM060/50		60		50	50/500	3395001835	1,02

HTKLAP050	SPÄTNÁ KLAPKA		1	3395001961	40,00
-----------	---------------	---	---	------------	-------









SPÄTNÁ KLAPKA Z POLYPROPYLÉNU DN50 mm S MOŽNOSŤOU MECHANICKÉHO UZATVORENIA













TVAROVKY DN 32 - 160 mm

Objednávaci kód		Balenie Zásobník/paleta	Objednávaci SAP kód	Cena EUR/ks	
KADH050	VETRACIA HLAVICA S UV OCHRANOU	10/180	3395002032	6,24	
KADH075		5/75	3395002033	10,00	
KADH110		5/45	3395002034	12,80	
KADH125	D125 sa dodáva bez manžety	1/20	3395002035	23,20	
					
MGNO150	MAZIVO TUBA 150 g	50/2100	3395002036	1,75	
MGNO250	MAZIVO TUBA 250 g	50/1800	3395002037	2,68	
MGN2000	MAZIVO VEDRO 2000 g	1/120	3395002038	12,60	
					
HTPM050	PROTIPOŽIARNA MANŽETA	1	3395004229	72,60	
HTPM075		1	3395004230	80,00	
HTPM110		1	3395004231	109,50	
HTPM125		1	3395004232	134,70	
HTPM160		1	3395004233	241,00	
					
HTCS-A	OBÍMKA POLO-CLIP	DN 32/40/50	1	3395001877	2,11
HTCS-B		DN 75/110	1	3395001878	4,21
HTCS-C		DN 125/160	1	HTCS-C	8,00
					
HTCS-HS1	RÝCHLOUPÍNACIA OBJÍMKA POLO-CLIP HS	DN75/110	1	3395003524	8,11
					
HTCS-C3S	VLOŽKA PRE TLMIENIE HLUKU		1	3395003523	10,40
	obsah balenia: tlmiaci prvok, skrutka, hmoždinka, podložka				
					







RÚRY DN 32 - 160 mm

Objednávaci kód		Balenie ks	Objednávaci SAP kód	Cena EUR/ks
M3B+32/150		30/1800	3296341007	1,61
M3B+32/250		30/1200	3296341008	1,89
M3B+32/500		30/720	3296341009	2,78
M3B+32/1000		20/500	3296341010	4,52
M3B+32/1500		20/500	3296341011	6,66
M3B+32/2000		20/500	3296341012	9,92
M3B+40/150		20/1680	3296342013	1,57
M3B+40/250		20/1200	3296342014	2,04
M3B+40/500		20/720	3296342015	2,68
M3B+40/1000		20/400	3296342016	4,19
M3B+40/1500		20/400	3296342017	6,74
M3B+40/2000		20/400	3296342018	8,33
M3B+50/150		20/1120	3296342019	1,60
M3B+50/250		20/840	3296342020	2,04
M3B+50/500		20/480	3296342021	2,89
M3B+50/1000		20/240	3296342022	4,82
M3B+50/1500		20/240	3296342023	7,24
M3B+50/2000		20/240	3296342024	8,99
M3B+75/150		20/480	3296343015	2,50
M3B+75/250		20/360	3296343016	2,76
M3B+75/500		20/240	3296343017	4,49
M3B+75/1000		10/120	3296343018	7,24
M3B+75/1500		10/120	3296343019	10,50
M3B+75/2000		10/120	3296343020	13,20
M3B+75/2650	10/120	3296343021	18,70	
M3B+90/150		14/336	3296343022	3,80
M3B+90/250		14/252	3296343023	4,85
M3B+90/500		14/168	3296343024	7,09
M3B+90/1000		7/77	3296343025	10,80
M3B+90/1500		7/77	3296343026	15,50
M3B+90/2000		7/77	3296343027	20,20
M3B+90/2650	7/77	3296343028	28,30	
M3B+110/150		10/240	3296344022	4,65
M3B+110/250		10/180	3296344023	5,53
M3B+110/500		10/120	3296344024	8,12
M3B+110/1000		5/55	3296344025	14,10
M3B+110/1500		5/55	3296344026	20,00
M3B+110/2000		5/55	3296344027	26,00
M3B+110/2650	5/55	3296344028	36,00	
M3B+125/150		8/144	3296344029	6,18
M3B+125/250		8/96	3296344030	8,29
M3B+125/500		8/96	3296344031	11,99
M3B+125/1000		3/39	3296344032	20,00
M3B+125/1500		3/39	3296344033	29,00
M3B+125/2000		3/39	3296344034	38,00
M3B+125/2650	3/39	3296344035	50,00	
M3B+160/150		6/72	3296344036	9,29
M3B+160/250		6/72	3296344037	12,00
M3B+160/500		6/48	3296344038	17,00
M3B+160/1000		3/24	3296344039	28,00
M3B+160/1500		3/24	3296344040	42,00
M3B+160/2000		3/24	3296344041	53,00
M3B+160/2650	3/24	3296344042	71,00	

TVAROVKY DN 32 - 160 mm

Objednací kód	KOLENO		Balenie		Objednací SAP kód	Cena EUR/ks
			Uhol	ks		
M3B+B32/15	KOLENO 15°		15°	70/3360	3496102859	1,10
M3B+B32/30	KOLENO 30°		30°	70/3360	3496102860	1,10
M3B+B32/45	KOLENO 45°		45°	70/3360	3496102861	1,10
M3B+B32/67	KOLENO 67°		67°	70/3360	3496102862	1,10
M3B+B32/87	KOLENO 87°		87°	70/3360	3496102863	1,10
M3B+B40/15	KOLENO 15°		15°	20/1920	3496103031	1,33
M3B+B40/30	KOLENO 30°		30°	20/1920	3496103032	1,33
M3B+B40/45	KOLENO 45°		45°	20/1920	3496102531	1,33
M3B+B40/67	KOLENO 67°		67°	20/1920	3496103113	1,71
M3B+B40/87	KOLENO 87°		87°	20/1920	3496102535	1,33
M3B+B50/15	KOLENO 15°		15°	20/960	3496103033	1,41
M3B+B50/30	KOLENO 30°		30°	20/960	3496103034	1,41
M3B+B50/45	KOLENO 45°		45°	20/960	3496102494	1,41
M3B+B50/67	KOLENO 67°		67°	20/960	3496103114	1,51
M3B+B50/87	KOLENO 87°		87°	20/960	3496102496	1,41
M3B+B75/15	KOLENO 15°		15°	20/480	3496103035	2,62
M3B+B75/30	KOLENO 30°		30°	20/480	3496103036	2,73
M3B+B75/45	KOLENO 45°		45°	20/480	3496102543	2,73
M3B+B75/67	KOLENO 67°		67°	20/480	3496103115	3,05
M3B+B75/87	KOLENO 87°		87°	20/480	3496102547	2,80
M3B+B90/15	KOLENO 15°		15°	20/320	3496103037	4,37
M3B+B90/30	KOLENO 30°		30°	20/320	3496103038	4,37
M3B+B90/45	KOLENO 45°		45°	20/320	3496102552	4,37
M3B+B90/67	KOLENO 67°		67°	20/320	3496103116	4,37
M3B+B90/87	KOLENO 87°		87°	20/320	3496102556	4,37
M3B+B110/15	KOLENO 15°		15°	20/240	3496103039	4,40
M3B+B110/30	KOLENO 30°		30°	20/240	3496102560	4,40
M3B+B110/45	KOLENO 45°		45°	20/240	3496102498	4,50
M3B+B110/67	KOLENO 67°		67°	20/240	3496103117	4,70
M3B+B110/87	KOLENO 87°		87°	20/240	3496102563	4,70
M3B+B125/15	KOLENO 15°		15°	16/192	3496103118	8,00
M3B+B125/30	KOLENO 30°		30°	16/192	3496103119	8,00
M3B+B125/45	KOLENO 45°		45°	16/192	3496102568	8,20
M3B+B125/87	KOLENO 87°		87°	16/192	3496102571	10,50
M3B+B160/15	KOLENO 15°			15°	12/72	3496103103
M3B+B160/30	KOLENO 30°	30°		6/72	3496103104	14,10
M3B+B160/45	KOLENO 45°	45°		6/72	3496102576	14,10
M3B+B160/87	KOLENO 87°	87°		4/48	3496102578	19,00
M3B+BL50/87	OBLÚK 87°			87°	20/480	3496103144
M3B+BL75/87			87°	20/480	3496103138	5,25
M3B+BL110/87			87°	20/480	3496103140	9,24

TVAROVKY DN 32 - 160 mm

Objednávaci kód	Objednávacia	Uhol	Balenie		Objednávaci SAP kód	Cena EUR/ks
			ks			
M3B+EP110/75/67L	PANELÁKOVÁ ROHOVÁ ODBOČKA 	67°	1		3295354321	37,00
M3B+EP110/75/67P		67°	1		3295354322	37,00
M3B+EP110/75/87L		87°	1		3295354323	37,00
M3B+EP110/75/87P		87°	1		3295354324	37,00
M3B+EK110/75/67L	PANELÁKOVÁ ROHOVÁ ODBOČKA KRÁTKA 	67°	1		3295354325	37,00
M3B+EK110/75/67P		67°	1		3295354320	37,00
M3B+ED110/110/45	DVOJITÁ ROHOVÁ ODBOČKA 45° 	45°	12/72		3295354318	42,00
M3B+ED110/110/87	DVOJITÁ ROHOVÁ ODBOČKA 87° 	87°	12/72		3496103108	16,00
M3B+DA110/50/87	DVOJITÁ ODBOČKA 87 	87°	5/120		1533000628	65,00
M3B+DA110/110/87		*	87°	5/60		1533000629
M3B+EA32/32/45	ODBOČKA 45° 	45°	20/1920		3496102866	2,25
M3B+EA40/32/45		45°	20/960		3496103123	2,29
M3B+EA40/40/45		45°	20/960		3496102637	2,29
M3B+EA50/32/45		45°	18/864		3496103125	2,70
M3B+EA50/40/45		45°	20/480		3496103127	2,85
M3B+EA50/50/45		45°	20/480		3496102647	2,65
M3B+EA75/50/45		45°	20/240		3496102651	3,60
M3B+EA75/75/45		45°	20/240		3496102656	4,74
M3B+EA90/50/45		45°	20/240		3496102661	5,80
M3B+EA90/75/45		45°	20/160		3496102665	6,40
M3B+EA90/90/45		45°	20/160		3496102669	6,40
M3B+EA110/50/45		45°	20/160		3496102512	6,40
M3B+EA110/75/45		45°	16/128		3496102679	7,20
M3B+EA110/90/45		45°	16/128		3496102684	9,50
M3B+EA110/110/45		45°	16/96		3496102518	9,20
M3B+EA125/110/45		45°	16/96		3496102692	16,90
M3B+EA125/125/45		45°	5/60		3496102698	28,00
M3B+EA160/110/45		45°	6/48		3496102704	36,00
M3B+EA160/125/45		45°	6/36		3496102756	44,00
M3B+EA160/160/45	45°	4/32		3496102709	45,00	
M3B+EA50/50/67	ODBOČKA 67° 	67°	20/480		3496103129	3,40
M3B+EA110/50/67		67°	20/160		3496103130	6,20
M3B+EA110/75/67		67°	20/160		3496103131	7,60
M3B+EA110/110/67		67°	14/84		3496103132	8,90

Poznámka:

*) tvarovky s rádiusom

Ceny sú bez DPH

Cenník platný od 1.6.2026

TVAROVKY DN 32 - 160 mm

Objednávaci kód		Uhol	Balenie ks	Objednávaci SAP kód	Cena EUR/ks	
M3B+EA32/32/87		87°	20/1920	3496102867	2,25	
M3B+EA40/32/87		87°	20/960	3496103124	2,25	
M3B+EA40/40/87		87°	20/960	3496102640	2,30	
M3B+EA50/32/87		87°	18/864	3496103126	2,49	
M3B+EA50/40/87		87°	20/480	3496103128	3,40	
M3B+EA50/50/87		87°	20/480	3496102509	2,65	
M3B+EA75/50/87		87°	20/320	3496102654	3,70	
M3B+EA75/75/87		87°	20/240	3496102659	4,90	
M3B+EA90/50/87		87°	20/240	3496102663	6,50	
M3B+EA90/75/87		87°	20/160	3496102667	6,50	
M3B+EA90/90/87		*	87°	15/180	3496102672	6,50
M3B+EA110/50/87			87°	24/192	3496102515	6,50
M3B+EA110/75/87			87°	20/160	3496102682	7,50
M3B+EA110/90/87		*	87°	20/120	3496102686	8,60
M3B+EA110/110/87		*	87°	14/84	3496102689	9,60
M3B+EA125/110/87			87°	8/96	3496102695	17,50
M3B+EA125/125/87		87°	6/72	3496102701	27,00	
M3B+EA160/110/87		87°	6/36	3496102706	31,00	
M3B+EA160/160/87		87°	6/36	3496102711	51,00	







M3B+R50/32			20/1920	3496103120	1,41
M3B+R50/40			20/1920	3496102590	1,77
M3B+R75/40			20/960	3496102593	2,25
M3B+R75/50			20/960	3496102595	2,22
M3B+R90/50			18/864	3496102597	3,78
M3B+R90/75			24/576	3496102599	4,36
M3B+R110/50			20/480	3496102602	3,40
M3B+R110/75			20/480	3496102604	3,95
M3B+R110/90			12/288	3496102608	4,70
M3B+R125/110			12/288	3496102606	7,60
M3B+R160/110			20/120	3496102610	11,60
M3B+R160/125			14/168	3496102612	11,60

Objednávaci kód	REDUKCIA KRÁTKA				
M3B+R40/32K			60/2880	70021408	3,06
M3B+R50/32K			60/2880	70024364	3,54
M3B+R50/40K			60/2880	70007119	3,80
M3B+R75/50K			60/2880	70007120	4,50
M3B+R90/40K			60/2880	3295353420	5,99
M3B+R90/50K			60/2880	3295353421	5,99
M3B+R90/75K			60/2880	3295353422	5,99
M3B+R110/40K			25/600	70007066	5,99
M3B+R110/50K			20/480	70007121	5,99
M3B+R110/75K			20/480	70007774	6,95
M3B+R110/90K			20/480	3295354420	6,95
M3B+R160/110K		20/120	3496102610	6,95	

M3B+RI50/40	REDUKCIA VNÚTORNÁ		10	1195008828	19,00
M3B+RI90/50			10	1195008830	22,00
M3B+RI110/50			10	1195008834	19,00
M3B+RI160/110			10	1195008849	52,00

M3B+RE50		ČISTIACI KUS	25/600	3496103121	6,40
M3B+RE75		20/240	3496103105	6,90	
M3B+RE90		12/144	3496102629	10,20	
M3B+RE110		20/120	3496102631	10,90	
M3B+RE125		8/96	3496103122	23,00	
M3B+RE160		6/48	3496103106	35,00	

TVAROVKY DN 32 - 160 mm

Objednávaci kód		Balenie ks	Objednávaci SAP kód	Cena EUR/ks
M3B+U32	PRESUVNÉ HRDLO 	30/2880	3496102865	1,63
M3B+U40		20/1280	3496102613	1,63
M3B+U50		20/960	3496102500	1,91
M3B+U75		20/480	3496102614	3,65
M3B+U90		16/384	3496102615	5,20
M3B+U110		20/240	3496102501	5,60
M3B+U125		8/192	3496102616	9,90
M3B+U160		12/96	3496102617	16,10
M3B+L40	PREDĹŽENÉ HRDLO 	20/1280	3496102619	2,52
M3B+L50		20/960	3496102621	2,64
M3B+L75		8/384	3496102623	5,16
M3B+L90		12/288	3496102625	8,30
M3B+L110		15/180	3496102503	8,30
M3B+M32	HRDLOVÁ ZÁTKA 	150/14400	3496102864	0,48
M3B+M40		40/3840	3496102763	0,76
M3B+M50		40/3840	3496102764	0,77
M3B+M75		40/1920	3496102765	1,41
M3B+M110		20/960	3496102584	2,43
M3B+M125		14/672	3496102766	5,01
M3B+M160	16/384	3496102767	7,89	
M3B+MA110	ODVETRÁVACIA TVAROVKA 	9	1533000626	179,00
M3B+MA160		9	1533000627	245,00
M3B+KB110/87	AKUSTICKÉ SPODNÉ KOLENO 	9	4196555619	410,00
MADH050BB3020	VETRACIA HLAVICA ČIERNA S UV OCHRANOU 	1	1533000845	120,00
MADH075BB3020		1	1533000846	120,00
MADH110BB3020		1	1533000847	120,00
MADH125BB3020		1	1533000848	120,00
MADH160BB3030		1	1533000849	190,00
MADH110BB5020		1	1533000850	160,00
MADH125BB5020		1	1533000851	150,00
MADH160BB5030		1	1533000852	220,00
MADH110BB5040		1	1533000853	170,00
MADH125BB5040		1	1533000854	170,00
MADH110BB8020		1	1533000855	180,00
MADH125BB8020		1	1533000856	190,00
MADH160BB8030		1	1533000857	250,00
MADH110BB8040		1	1533000858	210,00
MADH125BB8040		1	1533000859	210,00

TVAROVKY DN 32 - 160 mm

Objednávaci kód		Balenie ks	Objednávaci SAP kód	Cena EUR/ks
PRIVZDUŠŇOVACÍ VENTIL ARIO				
ARIO W	biely	9/270	3395001827	53,00
ARIO B	hnedý	9/270	ARIO B	56,00
M3B+S32	PRIPOJOVACÍ KUS PRIAMY	vrátane mažety 5/4" - 6/4" 20/1920	3496102758	4,41
M3B+S40		vrátane mažety 5/4" - 6/4" 20/1920	3496102759	4,41
M3B+S50		vrátane mažety 5/4" - 6/4" 20/1920	3496102760	4,41
M3B+SW32	PRIPOJOVACIE KOLENO	vrátane mažety 5/4" - 6/4" 20/1920	3496103112	4,41
M3B+SW40		vrátane mažety 5/4" - 6/4" 20/1920	3496102524	4,41
M3B+SW50		vrátane mažety 5/4" - 6/4" 20/960	3496102527	4,41
M3B+NI2L	GUMENÁ MANŽETA PRE M3B+S, M3B+SW	manžeta 2" 20		2,10
M3B+NI5/4/6/4		manžeta 5/4" - 6/4" 20	3395005137	2,40
OBJÍMKY PIPELIFE				
M3B+BSE110	PIPELIFE objímka jednoduchá D110	42	3496103159	12,00
M3B+BSE125	PIPELIFE objímka jednoduchá D125	42	3496103162	16,00
M3B+BSE160	PIPELIFE objímka jednoduchá D160	32	3496103166	17,00
M3B+BSD110	PIPELIFE objímka dvojitá D110	84	3496103158	23,00
M3B+BSD125	PIPELIFE objímka dvojitá D125	84	3496103161	29,00
M3B+BSD160	PIPELIFE objímka dvojitá D160	64	3496103164	32,00
M3B+BSL110	PIPELIFE objímka volná D110	84	3496103160	12,00
M3B+BSL125	PIPELIFE objímka volná D125	84	3496103163	16,00
M3B+BSL160	PIPELIFE objímka volná D160	64	3496103165	17,00
OBJÍMKY BISMAT® 1000				
3395004109	BISMAT® 1000 DN75	5	3395004109	41,00
3395004110	BISMAT® 1000 DN110	5	3395004110	44,00
3395004111	BISMAT® 1000 DN125	5	3395004111	62,00
3395004112	BISMAT® 1000 DN160	5	3395004112	68,00
OBJÍMKY BIFIX 5000 G2				
3395004761	BIFIX 5000 G2 DN75	50	3395004761	7,00
3395004762	BIFIX 5000 G2 DN90	25	3395004762	7,20
3395004763	BIFIX 5000 G2 DN110	25	3395004763	8,10
3395004764	BIFIX 5000 G2 DN125	25	3395004764	9,30
3395004765	BIFIX 5000 G2 DN160	10	3395004765	12,70

Objednávaci kód		Dimenzia	Balenie	MJ	Objednávaci SAP kód	Cena EUR/ks
VD040H-5M		40x3	1	ks	3395003538	13,00
VD050H-5M		50x3	1	ks	3395003539	16,00
VD056-5M		56x3	1	ks	3395003540	30,00
VD063H-5M		63x3	1	ks	3395003541	21,00
VD075H-5M		75x3	1	ks	3395003542	27,00
VD090H-5M		90x3,5	1	ks	3395003543	34,00
VD110H-5M		110x4,3	1	ks	3395003544	50,50
VD125H-5M		125x4,9	1	ks	3395003545	62,00
VD160H-5M		160x6,2	1	ks	3395003546	102,00
VD200H-5M SDR26		200x7,7	1	ks	3196004519	150,00
VD250H-5M SDR26		250x9,7	1	ks	3196004520	230,00
VD315H-5M SDR26		315x12,2	1	ks	3196004521	355,00

Objednávaci kód		Dimenzia	Balenie	MJ	Objednávaci SAP kód	Cena EUR/ks
VDW040-88		40	1	ks	3395003563	2,10
VDW050-88		50	1	ks	3395003564	1,80
VDW056-88		56	1	ks	3395003565	3,00
VDW063-88		63	1	ks	3395003566	4,00
VDW075-88		75	1	ks	3395003567	5,30
VDW090-88		90	1	ks	3395003568	7,20
VDW110-88		110	1	ks	3395003569	7,10
VDW125-88		125	1	ks	3395003570	12,60
VDW160-88		160	1	ks	3395003571	29,00

Objednávaci kód		Dimenzia	Balenie	MJ	Objednávaci SAP kód	Cena EUR/ks
VDW040-45		40	1	ks	3395003573	1,60
VDW050-45		50	1	ks	3395003574	1,70
VDW056-45		56	1	ks	3395003575	2,60
VDW063-45		63	1	ks	3395003576	2,70
VDW075-45		75	1	ks	3395003577	4,20
VDW090-45		90	1	ks	3395003578	6,70
VDW110-45		110	1	ks	3395003579	6,20
VDW125-45		125	1	ks	3395003580	8,40
VDW160-45		160	1	ks	3395003581	23,00
VDW200-45		200	1	ks	3395003582	55,00
VDW250-45		250	1	ks	3395003583	90,00
VDW315-45		315	1	ks	3395003584	111,00

PRO ROOF

Objednávaci kód		Dimenzia	Balenie	MJ	Objednávaci SAP kód	Cena EUR/ks
VDAG040-45		40/40	1	ks	3395003586	5,20
VDAG050-45		50/50	1	ks	3395003587	4,30
VDAG056-45		56/56	1	ks	3395003588	6,70
VDAG063-45		63/63	1	ks	3395003589	7,40
VDAG075-45		75/75	1	ks	3395003590	7,10
VDAG090-45		90/90	1	ks	3395003591	10,20
VDAG110-45		110/110	1	ks	3395003592	10,20
VDAG125-45		125/125	1	ks	3395003593	14,70
VDAG160-45		160/160	1	ks	3395003594	44,00
VDAG200-45		200/200	1	ks	3395003595	115,00
VDAG250-45		250/250	1	ks	3395003596	490,00
VDAG315-45		315/315	1	ks	3395003597	320,00

Objednávaci kód		Dimenzia	Balenie	MJ	Objednávaci SAP kód	Cena EUR/ks
VDAG050/40-45		50/40	1	ks	3395003599	4,40
VDAG056/50-45		56/50	1	ks	3395003600	5,50
VDAG063/40-45		63/40	1	ks	3395003601	5,60
VDAG090/56-45		90/56	1	ks	3395003610	10,00
VDAG063/50-45		63/50	1	ks	3395003602	6,70
VDAG063/56-45		63/56	1	ks	3395003603	5,60
VDAG075/40-45		75/40	1	ks	3395003604	6,90
VDAG090/75-45		90/75	1	ks	3395003612	9,40
VDAG075/50-45		75/50	1	ks	3395003605	6,40
VDAG075/56-45		75/56	1	ks	3395003606	6,80
VDAG090/40-45		90/40	1	ks	3395003608	8,80
VDAG075/63-45		75/63	1	ks	3395003607	6,70
VDAG090/50-45		90/50	1	ks	3395003609	9,30
VDAG090/63-45		90/63	1	ks	3395003611	9,30
VDAG110/40-45		110/40	1	ks	3395003613	12,90
VDAG110/50-45		110/50	1	ks	3395003614	10,00
VDAG110/56-45		110/56	1	ks	3395003615	10,40
VDAG110/63-45		110/63	1	ks	3395003616	12,00
VDAG110/75-45		110/75	1	ks	3395003617	10,00
VDAG110/90-45		110/90	1	ks	3395003618	11,80
VDAG125/40-45		125/40	1	ks	3395003619	12,80
VDAG125/50-45		125/50	1	ks	3395003620	19,00
VDAG125/56-45		125/56	1	ks	3395003621	21,00
VDAG125/63-45		125/63	1	ks	3395003622	19,40
VDAG125/75-45		125/75	1	ks	3395003623	15,50
VDAG125/90-45		125/90	1	ks	3395003624	22,00
VDAG125/110-45		125/110	1	ks	3395003625	14,00
VDAG160/110-45		160/110	1	ks	3395003626	36,00
VDAG160/125-45		160/125	1	ks	3395003627	44,00
VDAG200/110-45		200/110	1	ks	3395003628	78,00
VDAG200/125-45		200/125	1	ks	3395003629	118,00
VDAG200/160-45		200/160	1	ks	3395003630	103,00
VDAG250/110-45		250/110	1	ks	3395003631	264,00
VDAG250/125-45		250/125	1	ks	3395003632	199,00
VDAG250/160-45	250/160	1	ks	3395003633	210,00	
VDAG250/200-45	250/200	1	ks	3395003634	279,00	
VDAG315/110-45	315/110	1	ks	3395003635	260,00	
VDAG315/125-45	315/125	1	ks	3395003636	260,00	
VDAG315/160-45	315/160	1	ks	3395003637	260,00	
VDAG315/200-45	315/200	1	ks	3395003638	270,00	
VDAG315/250-45	315/250	1	ks	3395003639	299,00	

PRO ROOF

Objednávaci kód		Dimenzia	Balenie	MJ	Objednávaci SAP kód	Cena EUR/ks
VDTOK040-RO-V	 PREDLŽENÉ HRDLO KRÁTKE S OCHRANÝM VIEČKOM PEHD	40	1	ks	VDTOK040-RO-V	4,50
VDTOK050-RO-V		50	1	ks	VDTOK050-RO-V	5,70
VDTOK056-RO-V		56	1	ks	VDTOK056-RO-V	3,50
VDTOK063-RO-V		63	1	ks	VDTOK063-RO-V	6,70
VDTOK056/63-RO-V		56/63	1	ks	VDTOK056/63-RO-V	6,30
VDTOK075-RO-V		75	1	ks	VDTOK075-RO-V	8,20
VDTOK090-RO-V		90	1	ks	VDTOK090-RO-V	10,30
VDTOK110-RO-V		110	1	ks	VDTOK110-RO-V	10,70
VDTOK125-RO-V		125	1	ks	VDTOK125-RO-V	14,20
VDTOK160-RO-V		160	1	ks	VDTOK160-RO-V	31,00
VDTOK200-RO-V		200	1	ks	VDTOK200-RO-V	165,00
VDTOK250-RO-V		250	1	ks	VDTOK250-RO-V	180,00
VDTOK315-RO-V		315	1	ks	VDTOK315-RO-V	219,00

VDTOK040-HO-V	 PREDLŽENÉ HRDLO DLHÉ S OCHRANÝM VIEČKOM PEHD	40	1	ks	3395003935	8,40
VDTOK050-HO-V		50	1	ks	3395003936	8,50
VDTOK056-HO-V		56	1	ks	3395003937	9,60
VDTOK063-HO-V		63	1	ks	3395003938	11,10
VDTOK075-HO-V		75	1	ks	3395003939	11,40
VDTOK090-HO-V		90	1	ks	3395003940	24,50
VDTOK110-HO-V		110	1	ks	3395003941	19,00
VDTOK125-HO-V		125	1	ks	3395003942	27,30
VDTOK160-HO-V		160	1	ks	3395003943	33,00
VDTOK200-HO-V		200	1	ks	3395003944	130,00
VDTOK250-HO		250	1	ks	3395003945	231,00
VDTOK315-HO		315	1	ks	3395003946	375,00

VDTISZ040	 ČISTIACI KUS PEHD	40	1	ks	3395003728	17,60
VDTISZ050		50	1	ks	3395003729	20,90
VDTISZ056		56	1	ks	3395003730	26,00
VDTISZ063		63	1	ks	3395003731	20,50
VDTISZ075		75	1	ks	3395003732	22,00
VDTISZ090		90	1	ks	3395003733	32,00
VDTISZ110		110	1	ks	3395003734	22,50
VDTISZ125		125	1	ks	3395003735	48,00
VDTISZ160		160	1	ks	3395003736	81,00
VDTISZ200		200	1	ks	3395003737	164,00
VDTISZ250		250	1	ks	3395003738	189,00
VDTISZ315		315	1	ks	3395003739	235,00

PRO ROOF

Objednávaci kód		Dimenzia	Balenie	MJ	Objednávaci SAP kód	Cena EUR/ks
VDTISZ110-45		110	1	ks	3395003740	39,90
VDTISZ125-45		125	1	ks	3395003741	48,00
VDTISZ160-45		160	1	ks	3395003742	70,00

Objednávaci kód	ELEKTROSPOJKA PEHD	Dimenzia	Balenie	MJ	Objednávaci SAP kód	Cena EUR/ks
VDEK040		40	1	ks	3395003743	4,30
VDEK050		50	1	ks	3395003744	4,80
VDEK056		56	1	ks	3395003745	6,50
VDEK063		63	1	ks	3395003746	7,00
VDEK075		75	1	ks	3395003747	6,20
VDEK090		90	1	ks	3395003748	7,20
VDEK110		110	1	ks	3395003749	7,40
VDEK125		125	1	ks	3395003750	10,40
VDEK160		160	1	ks	3395003751	17,10
VDEK200		200	1	ks	3395003752	115,00
VDEK250		250	1	ks	3395003753	172,00
VDEK315		315	1	ks	3395003754	240,00

Objednávaci kód	EXCENTRICKÁ REDUKCIA PEHD	Dimenzia	Balenie	MJ	Objednávaci SAP kód	Cena EUR/ks
VDR050/40-EX		50/40	1	ks	3395003755	2,20
VDR056/50-EX		56/50	1	ks	3395003756	2,40
VDR063/40-EX		63/40	1	ks	3395003757	1,80
VDR063/50-EX		63/50	1	ks	3395003758	1,80
VDR063/56-EX		63/56	1	ks	3395003759	2,50
VDR075/40-EX		75/40	1	ks	3395003760	2,70
VDR075/50-EX		75/50	1	ks	3395003761	2,20
VDR075/56-EX		75/56	1	ks	3395003762	2,30
VDR075/63-EX		75/63	1	ks	3395003763	2,40
VDR090/40-EX		90/40	1	ks	3395003764	2,50
VDR090/50-EX		90/50	1	ks	3395003765	2,80
VDR090/56-EX		90/56	1	ks	3395003766	2,50
VDR090/63-EX		90/63	1	ks	3395003767	2,90
VDR090/75-EX		90/75	1	ks	3395003768	2,70
VDR110/40-EX		110/40	1	ks	3395003769	4,10
VDR110/50-EX		110/50	1	ks	3395003770	3,60
VDR110/56-EX		110/56	1	ks	3395003771	3,80
VDR110/63-EX		110/63	1	ks	3395003772	3,70
VDR110/75-EX		110/75	1	ks	3395003773	3,20
VDR110/90-EX		110/90	1	ks	3395003774	3,50
VDR125/50-EX		125/50	1	ks	3395003775	5,30
VDR125/56-EX		125/56	1	ks	3395003776	6,90
VDR125/63-EX		125/63	1	ks	3395003777	7,20
VDR125/75-EX		125/75	1	ks	3395003778	7,20
VDR125/90-EX	125/90	1	ks	3395003779	7,20	
VDR125/110-EX	125/110	1	ks	3395003780	5,70	
VDR160/110-EX	160/110	1	ks	3395003781	9,40	
VDR160/125-EX	160/125	1	ks	3395003782	9,30	





Objednávaci kód		Dimenzia	Balenie	MJ	Objednávaci SAP kód	Cena EUR/ks
VDR160/110-EX-HO	EXCENTRICKÁ REDUKCIA DLHÁ PEHD 	160/110	1	ks	3395003783	40,00
VDR160/125-EX-HO		160/125	1	ks	3395003784	40,00
VDR200/110-EX-HO		200/110	1	ks	3395003785	88,00
VDR200/125-EX-HO		200/125	1	ks	3395003786	58,00
VDR200/160-EX-HO		200/160	1	ks	3395003787	46,00
VDR250/200-EX-HO		250/200	1	ks	3395003788	75,00
VDR315/200-EX-HO		315/200	1	ks	3395003789	152,00
VDR315/250-EX-HO		315/250	1	ks	3395003790	185,00

Objednávaci kód	PROTIPOŽIARNA MANŽETA	Dimenzia	Balenie	MJ	Objednávaci SAP kód	Cena EUR/ks
VDTVM040		40	1	ks	VDTVM040	82,00
VDTVM050		50	1	ks	VDTVM050	41,00
VDTVM056		56	1	ks	VDTVM056	103,00
VDTVM063		63	1	ks	VDTVM063	55,00
VDTVM075		75	1	ks	VDTVM075	62,00
VDTVM090		90	1	ks	VDTVM090	88,00
VDTVM110		110	1	ks	VDTVM110	100,00
VDTVM125		125	1	ks	VDTVM125	111,00
VDTVM160		160	1	ks	VDTVM160	136,00
VDTVM200		200	1	ks	VDTVM200	199,00
VDTVM250		250	1	ks	VDTVM250	213,00
VDTVM315	315	1	ks	VDTVM315	1530,00	

Objednávaci kód	STREŠNÁ VPUŠŤ	Dimenzia	Balenie	MJ	Objednávaci SAP kód	Cena EUR/ks
VDPL-DN75			1	ks	3196004250	199,00
VDPL-DN75-PVC			1	ks	3196004532	200,00
VDPL-DN75-FPO			1	ks	3196004533	200,00
VDPL-DN75-LAD			1	ks	3196004534	200,00

Objednávaci kód		Dimenzia	Balenie	MJ	Objednávaci SAP kód	Cena EUR/ks
VDHM-HE		vyhrievací kábel	1	ks	3395003885	105,00
VDHM-SSP		nerezový diel 600x600	1	ks	3395003886	140,00

PRO ROOF

Objednávaci kód		Dimenzia	Balenie	MJ	Objednávaci SAP kód	Cena EUR/ks	
VDEM040-U	JEDNODUCHÁ POTRUBNÁ SVORKA 	40	1	ks	3395003887	7,50	
VDEM050-U		50	1	ks	3395003888	7,50	
VDEM056-U		56	1	ks	3395003889	10,50	
VDEM063-U		63	1	ks	3395003890	10,50	
VDEM075-U		75	1	ks	3395003891	10,50	
VDEM090-U		90	1	ks	3395003892	14,50	
VDEM110-U		110	1	ks	3395003893	16,00	
VDEM125-U		125	1	ks	3395003894	20,00	
VDEM160-U		160	1	ks	3395003895	21,00	
VDEM200-U		200	1	ks	3395003896	54,00	
VDEM250-U		250	1	ks	3395003897	58,00	
VDEM315-U		315	1	ks	3395003898	75,00	
VDFM040-U		POTRUBNÁ SVORKA PRE PEVNÝ BOD SADA 	40	1	ks	3395003899	7,50
VDFM050-U			50	1	ks	3395003900	7,50
VDFM056-U	56		1	ks	3395003901	10,20	
VDFM063-U	63		1	ks	3395003902	10,20	
VDFM075-U	75		1	ks	3395003903	10,20	
VDFM090-U	90		1	ks	3395003904	15,20	
VDFM110-U	110		1	ks	3395003905	16,00	
VDFM125-U	125		1	ks	3395003906	21,00	
VDFM160-U	160		1	ks	3395003907	21,50	
VDFM200-U	200		1	ks	3395003908	54,00	
VDFM250-U	250		1	ks	3395003909	62,00	
VDFM315-U	315		1	ks	3395003910	77,00	
VDSIN38/40-U	MPC MONTÁŽNA KOLAJNIKA 6m 		38/40	1	ks	3395003912	129,00
VDSIN40/60-U			40/60	1	ks	3395003913	255,00
VDSINO1-U		27/18 + 28/30	1	ks	3395003947	9,50	
VDSINO2-U		38/40 + 40/60	1	ks	3395003948	11,50	
VDKAP38/40-U	UPÍNACIA KONZOLA 	38/40 M10	1	ks	3395003917	1,00	
VDKAP40/60-U		40/60 M10	1	ks	3395003918	1,00	
VDTRAPFM10-U	TRAPÉZOVÝ ZÁVES	M10	1	ks	3395003924	3,00	

INSTAPLAST PPR

RÚRY DN 20 - 200 mm

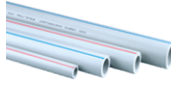
Objednávaci kód			Dimenzia	Balenie	MJ	Objednávaci SAP kód	Cena EUR/m
210129	Rúra S5 (PN 10) 4 m tyče 		20 x 1,9	4/100	m	3395320101	1,29
210134			25 x 2,3	4/100	m	3395320104	1,75
210139			32 x 2,9	4/40	m	3395320107	2,59
210144			40 x 3,7	4/40	m	3395320110	3,92

210130	Rúra S3,2 (PN 16) 4 m tyče s modrým prúžkom 		20 x 2,8	4/100	m	3395320102	1,37
210135			25 x 3,5	4/100	m	3395320105	2,12
210140			32 x 4,4	4/40	m	3395320108	3,39
210145			40 x 5,5	4/40	m	3395320111	5,23

210131	Rúra S2,5 (PN 20) 4 m tyče s červeným prúžkom 		20 x 3,4	4/100	m	3395320103	1,60
210136			25 x 4,2	4/100	m	3395320106	2,53
210141			32 x 5,4	4/40	m	3395320109	3,91
210146			40 x 6,7	4/40	m	3395320112	6,11

Poznámka:
Rúry priemerov D50, d63, d75, d90 a d110 tlakových rád PN10, PN16 a PN20 nahradili PP-RCT rúry UNIBETA rovnakých priemerov.

priemer 16 minimalne odberove množstvo 2-4t

290201	Rúra UNIBETA (PN 20) 		16x2,2	4/100	m	3395320301	1,20
290202		4 m tyče s oranžovým prúžkom	20x2,3	4/100	m	3395320302	1,48
290203			25x2,8	4/100	m	3395320303	2,27
290204			32x3,6	4/40	m	3395320304	3,65
290205			40x4,5	4/40	m	3395320305	5,64
290206			50x5,6	4/16	m	3395320306	9,13
290207			63x7,1	4/8	m	3395320307	14,10
290208			75x8,4	4/8	m	3395320308	21,20
290209			90x10,1	4	m	3395320309	32,00
290210			110x12,3	4	m	3395320310	45,30
290211			125x14,0	4	m	3395320311	121,00
290212			160x14,6	4	m	3395004938	269,00
290213			200x18,2	4	m	3395005235	367,00

Poznámka:
Rúra UNIBETA d125, d160 a d200 sú dodávané v zelenom prevedení!!!

Rúra UNIBETA d125, d160 a d200 je na objednanie!!!
Dodanie 3 - 5 týždňov podľa vyťaženia výroby

INSTAPLAST PPR

RÚRY DN 20 - 125 mm

Objednávaci kód		Dimenzia	Balenie	MJ	Objednávaci SAP kód	Cena EUR/m
290302	Rúra CARBO CRP (PN20)	20x2,8	4/100	m	3395320201	2,49
290303	4m tyče	25x3,5	4/100	m	3395320202	3,67
290304		32x4,4	4/40	m	3395320203	5,80
290305		40x5,5	4/40	m	3395320204	8,71
290306		50x6,9	4/16	m	3395320205	13,70
290307		63x8,6	4/8	m	3395320206	20,80
290308		75x8,4	4/8	m	3395320207	29,30
290309		90x10,1	4	m	3395320208	42,70
290310		110x12,3	4	m	3395320209	64,00
290311		125x14,0	4	m	290311	151,00

Carbo CRP



Poznámka:

Rúra CARBO CRP d125 je dodávaná v zelenom prevedení a na objednanie!!!

Dodanie 3 - 5 týždňov podľa vyťažnosti výroby

OXY H/C 20	Rúra CARBO OXY CRP Heat/Cool (PN20)	20x2,8	4/100	m	OXY H/C 20	3,25
OXY H/C 25	4m tyče s červeným prúžkom	25x3,5	4/100	m	OXY H/C 25	4,87
OXY H/C 32		32x4,4	4/40	m	3395005238	7,79

OXY H 40	Rúra CARBO OXY CRP Heat (PN20)	40x4,5	4/40	m	3395320401	10,30
OXY H 50	4m tyče s červeným prúžkom	50x5,6	4/16	m	3395320402	15,70
OXY H 63		63x7,1	4/8	m	3395320403	25,60
OXY H 75		75x8,4	4/8	m	3395320404	40,00
OXY H 90		90x10,1	4	m	3395320405	53,00
OXY H 110		110x12,3	4	m	3395320406	83,00
OXY H 125		125x14,0	4	m	OXY H 125	113,00

Carbo oxy CRP

OXY C 40	Rúra CARBO OXY CRP Cool (PN20)	40x3,7	4/40	m	OXY C 40	9,17
OXY C 50	4m tyče s modrým prúžkom	50x4,6	4/16	m	OXY C 50	15,60
OXY C 63		63x5,8	4/8	m	3395320501	21,60
OXY C 75		75x6,8	4/8	m	3395320502	32,00
OXY C 90		90x8,2	4	m	3395320503	44,00
OXY C 110		110x10,0	4	m	OXY C 110	66,70
OXY C 125		125x11,4	4	m	OXY C 125	84,00



Poznámka:

Rúra CARBO OXY CRP d125 je dodávaná v zelenom prevedení a na objednanie!!!

Dodanie 3 - 5 týždňov podľa vyťažnosti výroby

Objednávaci kód		Dimenzia	Balenie malé/veľké	MJ	Objednávaci SAP kód	Cena EUR/ks
600104	Žľab pozinkovaný	20x2m	1/25	ks	3395002769	3,58
600105		25x2m	1/25	ks	3395002770	3,73
600106		32x2m	1/25	ks	3395002771	4,49
600107		40x2m	1/25	ks	3395002772	5,56
600108		50x2m	1/25	ks	3395002773	6,85
600109		63x2m	1/25	ks	3395002774	8,04
600110		75x2m	1/25	ks	3395002775	10,20

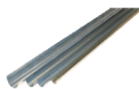

220402	Križenie rúr PN 20	hrdlové 20 x 3,4	10/50	ks	3395002583	2,44
220407		hrdlové 25 x 4,2	10/50	ks	3395002584	1,69
220412		32 x 5,4	5/20	ks	3395002585	2,41









220501	Dilatačná slučka PN 20	20 x 3,4	1/100	ks	3395002586	2,58
220502		25 x 4,2	1/80	ks	3395002587	3,50
220503		32 x 5,4	1/60	ks	3395002588	5,73
220504		40 x 6,7	1/40	ks	3395002589	9,00



INSTAPLAST PPR

TVAROVKY DN 20 - 200 mm

Objednávaci kód	PN 10 - PN20	Dimenzia	Balenie		MJ	Objednávaci SAP kód	Cena EUR/m
			malé/veľké				
220101	Koleno 45° 	16	50/200	ks	3395002561	0,91	
220102		20	50/500	ks	3395002562	0,38	
220103		25	50/300	ks	3395002563	0,60	
220104		32	20/100	ks	3395002564	0,94	
220105		40	5/25	ks	3395002565	2,55	
220106		50	5/20	ks	3395002566	3,05	
220107		63	5/20	ks	3395002567	9,04	
220108		75	2/8	ks	3395002568	13,10	
220109		90	1/6	ks	3395002569	18,30	
220110		110	1/5	ks	3395002570	24,30	
320111			125	1	ks	320111	69,00
320112			160	1	ks	320112	203,00
320113			200	1	ks	320113	419,00
220201	Koleno 90° 	16	50/250	ks	3395002571	0,48	
220202		20	50/400	ks	3395002572	0,25	
220203		25	50/300	ks	3395002573	0,43	
220204		32	20/100	ks	3395002574	0,59	
220205		40	10/60	ks	3395002575	1,30	
220206		50	10/30	ks	3395002576	2,65	
220207		63	5/20	ks	3395002577	5,15	
220208		75	2/6	ks	3395002578	11,90	
220209		90	1/6	ks	3395002579	20,80	
220210		110	1/4	ks	3395002580	26,00	
320211			125	1	ks	320211	94,00
320212			160	1	ks	320212	234,00
320213			200	1	ks	320213	469,00
220301	Koleno 90° vnútorné/vonkajšie 	20	50/300	ks	3395002581	0,38	
220302		25	50/250	ks	3395002582	0,51	
820303		32	20/100	ks	3395002782	1,13	
820330	Koleno 45° vnútorné/vonkajšie 	20	20/200	ks	3395002783	0,64	
820331		25	20/200	ks	3395002784	1,41	
820400	Koleno 90° redukované	20/25	1	ks	3395002783	0,64	
270501	Koleno 90° MZV - vonkajší závit 	16x1/2"	10/100	ks	270501	3,49	
270502		20x1/2"	10/150	ks	3395002731	3,39	
270504		20x3/4"	10/50	ks	3395002733	5,06	
270503		25x1/2"	10/50	ks	3395002732	3,74	
270505		25x3/4"	10/100	ks	3395002734	5,40	
270506		32x3/4"	10/50	ks	270506	6,33	
270507		32x1"	5/50	ks	3395002735	8,51	
280102	Koleno 90° MZD - vnútorný závit 	16x1/2"	10/100	ks	280102	3,30	
280103		20x1/2"	10/150	ks	3395002736	3,05	
280104		20x3/4"	10/100	ks	3395002737	4,30	
280105		25x1/2"	10/100	ks	3395002738	3,70	
280106		25x3/4"	10/100	ks	3395002739	4,28	
280107		32x3/4"	5/50	ks	280107	4,66	
280108		32x1"	5/50	ks	3395002740	7,93	
280001		Koleno 90° MZD vnútorné/vonkajšie 	20x1/2"	10/100	ks	280001	3,16





d125, d160 a d200 sú dodávané v zelenom prevedení!!!

Ceny sú bez DPH

Cenník platný od 1.6.2026

INSTAPLAST PPR

TVAROVKY DN 20 - 200 mm

Objednávaci kód	PN 10 - PN20	Dimenzia	Balenie malé/veľké	MJ	Objednávaci SAP kód	Cena EUR/ks
280624	Koleno 90° PM kovovým závitom a prevlečnou maticou 	16x3/4"	10/100	ks	280624	3,91
280625		20x3/4"	10/50	ks	280625	6,35
280630		20x1"	10/50	ks	280630	9,93
280629		25x3/4"	10/50	ks	280629	7,15
280628		32x1"	5/50	ks	280628	10,80
280627		32x5/4"	5/30	ks	280627	13,90
290501	Koleno 90° BJ s PM plastové s prevlečnou maticou 	16x1/2"	10/150	ks	290501	2,39
290503		20x1/2"	10/100	ks	290503	2,60
290504		20x3/4"	10/100	ks	3395002942	2,79
290505		25x3/4"	10/100	ks	290505	3,60
290506		25x1"	10/50	ks	290506	5,83
230401	Križ 	20	25/100	ks	3395002624	1,75
230402		25	25/100	ks	3395002625	2,30
230403		32	10/50	ks	3395002626	3,21
230305	T-kus redukovaný 	20x16x20	50/300	ks	3395002601	1,23
230306		20x25x20	50/150	ks	3395002602	1,79
230307		25x20x25	50/200	ks	3395002603	0,74
230308		25x25x20	50/150	ks	3395002604	0,81
230309		25x32x25	20/120	ks	3395002605	1,01
230310		25x20x20	20/100	ks	3395002606	1,14
230311		32x20x32	20/100	ks	3395002607	1,29
230312		32x20x25	20/100	ks	230312	1,76
230313		32x25x32	20/100	ks	3395002608	1,33
230314		32x32x25	20/100	ks	230314	0,99
230315		32x40x32	10/50	ks	230315	2,69
230316		40x20x40	10/60	ks	3395002609	1,98
230317		40x25x40	10/60	ks	3395002610	3,45
230318		40x32x40	10/50	ks	3395002611	3,34
230319		50x25x50	5/30	ks	3395002612	4,36
230320		50x32x50	5/30	ks	3395002613	3,89
230321		50x40x50	5/30	ks	3395002614	5,54
230324		63x32x63	5/20	ks	3395002616	8,54
230323		63x40x63	5/20	ks	3395002615	8,34
230325		63x50x63	2/16	ks	3395002617	8,56
230326	75x50x75	2/12	ks	3395002618	18,10	
230327	75x63x75	2/8	ks	3395002619	18,10	
230329	90x63x90	2/6	ks	3395002620	24,30	
230330	90x75x90	2/6	ks	3395002941	25,00	
230333	110x63x110	1/5	ks	3395002621	28,80	
230334	110x75x110	1/4	ks	3395002622	28,80	
230335	110x90x110	1/4	ks	3395002623	31,30	
330336	125x75x125	1	ks	330336	134,00	
330337	125x90x125	1	ks	330337	96,00	
330338	125x110x125	1	ks	330338	113,00	
330339	160x90x160	1	ks	330339	298,00	
330340	160x110x160	1	ks	330340	289,00	
330341	200x90x200	1	ks	330341	483,00	
330342	200x110x200	1	ks	330342	513,00	
330343	200x125x200	1	ks	330343	529,00	
330344	200x160x200	1	ks	330344	521,00	







d125, d160 a d200 sú dodávané v zelenom prevedení!!!

Ceny sú bez DPH

Cenník platný od 1.6.2026

INSTAPLAST PPR







TVAROVKY DN 20 - 200 mm

Objednávaci kód	PN 10 - PN20	Dimenzia	Balenie malé/veľké	MJ	Objednávaci SAP kód	Cena EUR/ks
230201		16	50/250	ks	3395002591	0,61
230202		20	50/300	ks	3395002592	0,35
230203		25	50/150	ks	3395002593	0,51
230204		32	20/100	ks	3395002594	1,11
230205		40	10/50	ks	3395002595	3,34
230206		50	5/30	ks	3395002596	5,11
230207		63	2/16	ks	3395002597	8,80
230208		75	1/6	ks	3395002598	20,10
230209		90	1/6	ks	3395002599	22,30
230210		110	1/4	ks	3395002600	29,10
330111		125	1	ks	330111	134,00
330112		160	1	ks	330112	319,00
330113		200	1	ks	330113	494,00
230102		20	10/50	ks	3395002590	1,91
230103		25	1	ks	3395005259	5,20
230104		32	1	ks	3395005260	8,13
230105		40	1	ks	3395005261	6,73
270302		20x1/2"	10/100	ks	3395002718	3,91
270303		25x1/2"	10/100	ks	3395004121	4,26
270304		25x3/4"	5/20	ks	3395002719	5,61
270305		32x1/2"	5/40	ks	270305	5,41
280304		20x1/2"	10/120	ks	3395002741	2,94
280305		20x3/4"	5/30	ks	3395002742	4,50
280306		25x1/2"	5/100	ks	3395002743	4,13
280307		25x3/4"	5/25	ks	3395002744	4,89
280308		32x1/2"	5/25	ks	3395002745	4,65
280309		32x3/4"	5/25	ks	3395002746	6,51
280310		32x1"	5/20	ks	3395002747	8,59
280202		20x3/4"	5/50	ks	3395320233	5,68
280208		20x1"	10/100	ks	3395320234	9,40
280203		25x3/4"	5/50	ks	3395320244	6,64
280204		25x1"	5/50	ks	3395320245	7,81
280205		32x3/4"	5/50	ks	3395320248	8,06
280206		32x1"	5/40	ks	280206	10,70
280207		32x5/4"	5/25	ks	3395320249	12,50
290601		16x1/2"	10/60	ks	290601	2,76
290603		20x1/2"	10/100	ks	3395320239	3,05
290604		20x3/4"	5/50	ks	3395004942	3,05
290605		20x1"	5/50	ks	3395320240	3,91
290606		25x3/4"	5/50	ks	3395320255	3,35
290607		25x1"	5/25	ks	3395320256	4,56
290609		32x3/4"	5/25	ks	3395320258	3,59
290610		32x1"	5/25	ks	3395320259	5,90
240301			20/16	50/200	ks	240301
240302	25/20		50/450	ks	3395002663	0,44
240306	32/20		50/250	ks	3395002667	0,68
240303	32/25		50/250	ks	3395002664	0,73
240304	40/32		10/100	ks	3395002665	1,46
240305	50/40		10/90	ks	3395002666	2,54
840310	63/50		1	KS	840310	7,84

d125, d160 a d200 sú dodávané v zelenom prevedení!!!

INSTAPLAST PPR

TVAROVKY DN 20 - 200 mm

Objednávaci kód	PN 10 - PN20	Dimenzia	Balenie malé/veľké	MJ	Objednávaci SAP kód	Cena EUR/ks	
240401	Priama spojka plastová 	20	10/50	ks	3395320232	5,33	
240402		25	10/50	ks	3395320241	6,10	
240403		32	10/50	ks	3395320242	6,40	
240101	Nátrubok 	16	50/250	ks	3395002634	0,34	
240102		20	50/600	ks	3395002635	0,28	
240103		25	50/400	ks	3395002636	0,34	
240104		32	20/200	ks	3395002637	0,68	
240105		40	20/100	ks	3395002638	1,15	
240106		50	10/70	ks	3395002639	2,39	
240107		63	5/30	ks	3395002640	3,70	
240108		75	2/30	ks	3395002641	7,09	
240109		90	1/16	ks	3395002642	16,00	
240110		110	1/10	ks	3395002643	18,10	
340111		125	1	ks	340111	45,00	
240202	Redukcia (redukcia vnútorná/vonkajšia) 	20/16	50/250	ks	3395002644	0,56	
240203		25/20	50/500	ks	3395002645	0,36	
240204		32/20	50/250	ks	3395002646	0,60	
240205		32/25	50/300	ks	3395002647	0,58	
240206		40/20	10/100	ks	3395002648	0,86	
240207		40/25	10/100	ks	3395002649	0,86	
240208		40/32	20/100	ks	3395002650	1,10	
240209		50/32	10/100	ks	3395002651	1,59	
240210		50/40	10/100	ks	3395002652	1,74	
240211		63/32	10/70	ks	3395002653	3,44	
240212		63/40	10/70	ks	3395002654	3,18	
240213		63/50	10/60	ks	3395002655	2,94	
240218		75/40	1	ks	3395002660	9,74	
240217		75/50	2/20	ks	3395002659	5,56	
240214		75/63	1/25	ks	3395002656	6,54	
240215	90/63	1	ks	3395002657	10,30		
240216	90/75	1	ks	3395002658	10,30		
240219	110/75	1	ks	3395002661	20,10		
240220	110/90	1	ks	3395002662	19,50		
340221	125/110	1	ks	340221	73,00		
340222	160/110	1	ks	340222	153,00		
340223	160/125	1	ks	340223	153,00		
340224	200/110	1	ks	340224	645,00		
340225	200/160	1	ks	340225	236,00		
200039	Rozoberateľný spoj 	20	10/100	ks	3395002552	5,41	
200040		25	10/50	ks	3395002553	9,63	
200041		32	10/30	ks	3395002554	11,70	
200042		40	5/20	ks	3395002555	19,90	
200043		50	2/8	ks	3395002556	40,00	
260301	Zátka vnútorná 	16	50/200	ks	3395002985	0,36	
260302		20	50/300	ks	3395002713	0,48	
260303		25	50/200	ks	3395002986	0,50	
260304		32	10/100	ks	3395002987	0,68	
260324	Montážni zátka s gumičkou 	dlhá	1/2" šedá	10/250	ks	3395002715	0,71
260326		dlhá	1/2" modrá	10/250	ks	3395002716	0,71
260327		dlhá	1/2" červená	10/250	ks	3395002717	0,71





d125, d160 a d200 sú dodávané v zelenom prevedení!!!

Ceny sú bez DPH

Cenník platný od 1.6.2026

INSTAPLAST PPR

TVAROVKY DN 20 - 125 mm

Objednávaci kód	PN 10 - PN20	Dimenzia	Balenie malé/veľké	MJ	Objednávaci SAP kód	Cena EUR/ks	
260201	 <p>Zátka/Záslepka na rúru</p>	16	50/400	ks	3395002703	0,96	
260202		20	50/200	ks	3395002704	0,41	
260203		25	50/200	ks	3395002705	0,50	
260204		32	10/100	ks	3395002706	0,76	
260205		40	5/50	ks	3395002707	3,31	
260206		50	5/30	ks	3395002708	3,93	
260207		63	5/25	ks	3395002709	4,44	
260208		75	5/20	ks	3395002710	10,30	
260209		90	2/6	ks	3395002711	12,50	
260210		110	2/8	ks	3395002712	21,30	
360211		125	1	ks	360211	93,00	
360212		160	1	ks	360212	121,00	
360213		200	1	ks	360213	205,00	
270402	 <p>DG - prechodka MZV - závit vonkajší</p>	16x3/8"	10/50	ks	270402	4,45	
270403		16x1/2"	10/50	ks	270403	3,31	
270417		20x3/8"	10/100	ks	270417	2,83	
270404		20x1/2"	10/150	ks	3395002720	2,79	
270405		20x3/4"	10/100	ks	3395002721	4,38	
270406		25x1/2"	10/100	ks	3395002722	3,51	
270407		25x3/4"	10/80	ks	3395002723	4,49	
270408		32x3/4"	5/50	ks	3395002724	6,35	
270409		32x1"	4/60	ks	3395002725	7,01	
270410		40x5/4"	4/20	ks	3395002726	17,80	
270411		50x6/4"	4/20	ks	3395002727	26,30	
270412		63x2"	2/12	ks	3395002728	36,30	
270413		75x2,5"	1/9	ks	3395002729	64,00	
270414		90x3"	1/6	ks	3395002730	94,00	
870415		110x4"	1	ks	870415	799,00	
370416	125x5"	1	ks	370416	934,00		
280403	 <p>DG – prechodka MZD - závit vnútorný</p>	16x1/2"	10/100	ks	3395003232	2,91	
280417		20x3/8"	10/100	ks	280417	2,48	
280404		20x1/2"	10/200	ks	3395002748	2,33	
280405		20x3/4"	10/100	ks	3395002749	3,75	
280406		25x1/2"	10/100	ks	3395002750	2,93	
280407		25x3/4"	10/100	ks	3395002751	3,66	
280408		32x3/4"	5/40	ks	3395004067	5,15	
280409		32x1"	4/60	ks	3395002752	6,73	
280410		40x5/4"	4/20	ks	3395002753	18,30	
280411		50x6/4"	4/20	ks	3395002754	26,30	
280412		63x2"	2/12	ks	3395002755	38,80	
280413		75x2,5"	2/8	ks	3395002756	68,00	
280414		90x3"	1/6	ks	3395002757	103,00	
880415		110x4"	1	ks	880415	563,00	
880416		125x5"	1	ks	880416	756,00	
290409	 <p>DG prechodka BJ s PM</p>	20x1/2"	10/100	ks	3395002764	2,65	
290411		prechodka s kovovým závitom a prevlečnou maticou	20x3/4"	10/100	ks	3395002765	3,21
290417		25x3/4"	10/100	ks	3395002766	3,19	
290419		25x1"	10/50	ks	3395002767	4,94	
290420		PM s dierou pre plombu	20x3/4"	10/100	ks	3395320237	3,21
290421		PM s dierou pre plombu	25x3/4"	10/100	ks	3395002768	3,34





d125, d160 a d200 sú dodávané v zelenom prevedení!!!

Ceny sú bez DPH

Cenník platný od 1.6.2026

INSTAPLAST PPR

TVAROVKY DN 20 - 75 mm

Objednávaci kód	PN 10 - PN20	Dimenzia	Balenie		MJ	Objednávaci SAP kód	Cena EUR/ks
			malé/veľké				
280602	DG - prechodka PM	16x3/4"	10/100		ks	280602	5,88
280603	prechodka s prevlečnou maticou	20x3/4"	10/100		ks	3395002758	5,88
280610		20x1/2"	10/100		ks	3395002763	5,23
280604		20x1"	10/50		ks	3395002759	12,20
280606		25x3/4"	10/50		ks	3395002761	7,85
280605		25x1"	10/40		ks	3395002760	12,50
280609		32x1"	5/25		ks	3395320250	12,10
280607		32x5/4"	5/50		ks	3395002762	17,40
260101	Nástenka MZD - závit vnútorný	16x3/8"	10/50		ks	260101	4,68
260102		16x1/2"	10/100		ks	3395002693	3,05
260103		20x1/2"	10/150		ks	3395002694	2,79
260109		25x1/2"	10/50		ks	3395002697	3,18
260110		25x3/4"	10/100		ks	3395002698	4,70
200029		Hollander - hrdlo s maticou	16 x 1/2"	10/150		ks	3395320231
200038		20 x 3/4"	10/150		ks	3395002551	2,56
200050		25 x 1"	5/100		ks	3395002558	4,76
260104	Priechodzia nástenka MZD	20x1/2"	10/100		ks	3395002695	3,35
260108	závit vnútorný	25x1/2"	5/50		ks	3395002696	5,31
260130	Nástenka MZD pre sadrokartón	20x1/2"	2/20		ks	3395002700	5,01
260131	Priečková nástenka MZD	20x1/2"	10/100		ks	3395002701	3,18
260132	Nástenka MZD s čapom	20x1/2"	10/150		ks	3395002702	2,81
260120	Nástenný komplet	20x1/2"	1/10		ks	3395002699	8,48
860140	Držiak nástenných kolien		5/100		ks	3395002786	2,18
800071	Šróbenie vnútorné	20x1/2"	25/100		ks	3395003273	5,31
800072		20x3/4"	25/75		ks	3395003274	8,21
800074		25x3/4"	25/75		ks	3395003275	8,43
800079		25x1"	25/50		ks	3395003276	12,80
800075		32x1"	25/50		ks	3395003277	13,00
800076		40x5/4"	25		ks	3395320225	18,40
800077		50x6/4"	10/20		ks	3395320226	28,80
800078		63x2"	5/10		ks	3395320229	28,80
800080		75x2,5"	5		ks	3395320230	115,00

INSTAPLAST PPR

TVAROVKY DN 20 - 200 mm

Objednávaci kód	PN 10 - PN20	Dimenzia	Balenie malé/veľké	MJ	Objednávaci SAP kód	Cena EUR/ks
800081		20x1/2"	25/100	ks	3395002780	6,85
800082		20x3/4"	25/75	ks	3395003278	10,60
800083		20x1"	25/50	ks	3395320220	10,70
800084		25x3/4"	25/75	ks	3395002781	10,70
800089		25x1"	25/50	ks	3395003279	14,00
800085		32x1"	25/50	ks	3395003280	16,60
800086		40x5/4"	25	ks	3395320223	19,00
800087		50x6/4"	10/20	ks	3395320224	31,30
800088		63x2"	8/10	ks	3395320227	59,00
800090		75x2,5"	5	ks	3395320228	118,00

Objednávaci kód	Navarovacie sedlo	Dimenzia	Balenie malé/veľké	MJ	Objednávaci SAP kód	Cena EUR/ks
869105		63x32	10/50	ks	3395002799	2,76
869106		75x32	10/50	ks	3395002800	2,76
869107		90x32	10/50	ks	3395002801	3,03
869108		110x32	5/30	ks	869108	4,20
869109		110x40	5/30	ks	869109	5,73

Objednávaci kód	Lemový nákrúžok	Dimenzia	Balenie malé/veľké	MJ	Objednávaci SAP kód	Cena EUR/ks
869001		40	1	ks	3395002787	3,29
869002		50	1	ks	3395002788	6,44
869003		63	1	ks	3395002789	7,31
869004		75	1	ks	3395002790	9,45
869005		90	1	ks	3395002791	12,20
869006		110	1	ks	3395002792	16,40
369007		125	1	ks	369007	31,25
369008		160	1	ks	369008	159,00
369008	200	1	ks	369008	216,00	

Objednávaci kód	Voľná príruha	Dimenzia	Balenie malé/veľké	MJ	Objednávaci SAP kód	Cena EUR/ks
869011		40/DN32	1	ks	3395002793	28,80
869012		50/DN40	1	ks	3395002794	35,00
869013		63/DN50	1	ks	3395002795	38,80
869014		75/DN65	1	ks	3395002796	54,00
869015		90/DN80	1	ks	3395002797	58,00
869016		110/DN90	1	ks	3395002798	71,00
869017		125/DN110	1	ks	869017	73,00
869018		160/DN125	1	ks	869018	121,00
869019		200/DN160 PN10	1	ks	869019	213,00
869020		200/DN160 PN16	1	ks	869020	213,00

Objednávaci kód	Ventil priamy plastový	Dimenzia	Balenie malé/veľké	MJ	Objednávaci SAP kód	Cena EUR/ks
250111		20	10/50	ks	3395002680	9,90
250112		25	10/40	ks	3395002681	13,30
250113		32	5/10	ks	3395002682	19,40
250114		40	2/8	ks	3395002683	26,30
250115		50	1/4	ks	3395002684	59,00
250116		63	1/4	ks	3395004248	86,00





d125, d160 a d200 sú dodávané v zelenom prevedení!!!





Ceny sú bez DPH

Cenník platný od 1.6.2026

INSTAPLAST PPR

TVAROVKY DN 20 - 75 mm

Objednávaci kód	PN 10 - PN20	Dimenzia	Balenie malé/veľké	MJ	Objednávaci SAP kód	Cena EUR/ks
650001	Filter 	25	2/20	ks	3395003930	14,60
250151	Priamy ventil podomietkový s chrómovou krytkou 	20	5/20	ks	3395003379	15,90
250152		25	5/20	ks	3395002686	18,30
240521	Nerozoberateľný guľový kohút s páčkou 	20	10/50	ks	3395002671	7,83
240522		25	10/40	ks	3395002672	10,70
240523		32	10/30	ks	3395002673	17,30
240524		40	2/16	ks	3395002674	24,60
240525		50	1/6	ks	3395002675	37,50
240526		63	1/5	ks	3395002676	51,00
240527		75	1/4	ks	3395002677	84,00
250204	Prichytka rúr 	16	50/250	ks	3395002689	0,23
250205		20	50/1000	ks	3395002690	0,10
250206		25	50/1000	ks	3395002691	0,13
240012		32	1	ks	3395002627	0,50
240013		40	1	ks	3395002628	0,56
240014		50	1	ks	3395002629	0,89
240015		63	1	ks	3395002630	1,21
240018		75	1	ks	3395002632	2,73
240017		90	1	ks	3395002631	3,36
240019		110	1	ks	3395002633	3,64
250201	Dvojprichytka 	16	20/500	ks	250201	0,40
250202		20	20/500	ks	3395002687	0,23
250203		25	20/300	ks	3395002688	0,29

Objednávaci kód		PRIEMER mm	Balenie	MJ	Objednávaci SAP kód	Cena EUR/m	
RP16x2-200PERT	PE-RT/Al/PE-RT rúra v súlade s ISO/DIS21003-1, 80C° PN 10 	16x2,0 mm	200	m	3395310111	1,08	
RP16x2-400PERT		16x2,0 mm	400	m	3395310113	1,08	
RP18x2-200PERT		18x2,0 mm	200	m	3395310121	1,67	
RP20x2-100PERT		20x2,0 mm	100	m	3395310126	1,78	
RP26x3-100PERT		26x3,0 mm	100	m	3395310134	3,55	
RP32x3-50PERT		32x3,0 mm	50	m	3395310145	4,70	
RP16x2-5PERT	PE-RT/Al/PE-RT rúra v súlade s ISO/DIS21003-1, 80C° PN 10 	16x2,0 mm	5/150	m	3395310119	1,27	
RP18x2-5PERT		18x2,0 mm	5/150	m	3395310122	2,04	
RP20x2-5PERT		20x2,0 mm	5/100	m	3395310132	2,06	
RP26x3-5PERT		26x3,0 mm	5/50	m	3395310138	4,14	
RP32x3-5PERT		32x3,0 mm	5/35	m	3395310146	5,37	
RP40x3,5-5PERT		40x3,5 mm	5	m	3395310149	13,00	
RP50x4-5PERT		50x4,0 mm	5	m	3395310150	27,00	
RP63x4,5-5PERT		63x4,5 mm	5	m	3395310151	46,00	
FT-R16-400	PE-RT/EVOH/PE-RT rúra na podlahové kúrenie s kyslíkovou bariérou 	16x2,0 mm	200	m	3395310101	0,82	
FT-R16-500		16x2,0 mm	400	m	3395310102	0,82	
FT-R17-400		17x2,0 mm	400	m	3395310103	0,95	
FT-R18-300		18x2,0 mm	300	m	3395310104	1,00	
FT-R18-400		18x2,0 mm	400	m	3395310105	1,00	
PLUFH16X2PERT-200	PE-RT/Al/PE-RT rúra na podlahové kúrenie 	16x2,0 mm	200	m	3395310108	1,05	
PLUFH16X2PERT-400		16x2,0 mm	400	m	3395310109	1,05	
RP16x2-50-IS-B-PERT	modrá	16x2,0 mm	50	m	3395310115	2,04	
RP16x2-50-IS-R-PERT	červená	16x2,0 mm	50	m	3395310117	2,04	
RP20x2-50-IS-B-PERT	modrá	20x2,0 mm	50	m	3395310128	2,46	
RP20x2-50-IS-R-PERT	červená	20x2,0 mm	50	m	3395310130	2,46	
RP26x3-50-IS-B-PERT	modrá	26x3,0 mm	50	m	3395310147	4,47	
RP26x3-50-IS-R-PERT	červená	26x3,0 mm	50	m	3395310148	4,47	
RP32x3-50-IS-B-PERT	modrá	32x3,0 mm	50	m	3395310141	5,54	
RP32x3-50-IS-R-PERT	červená	32x3,0 mm	50	m	3395310143	5,54	
CHRÁNIČKA - PE korugovaná rúra							
RP-PROT16-50R	červená	pre rúry 16x2	50	m	3395310162	0,70	
RP-PROT16-50B	modrá	pre rúry 16x2	50	m	3395310160	0,70	
RP-PROT16-50BK	čierna	pre rúry 16x2	50	m	3395310161	0,70	
RP-PROT20-50R	červená	pre rúry 20x2	50	m	3395310165	0,75	
RP-PROT20-50B	modrá	pre rúry 20x2	50	m	3395310163	0,75	
RP-PROT20-50BK	čierna	pre rúry 20x2	50	m	3395310164	0,75	
RP-PROT26-50R	červená	pre rúry 26x3	50	m	3395310168	1,16	
RP-PROT26-50B	modrá	pre rúry 26x3	50	m	3395310166	1,16	
RP-PROT26-50BK	čierna	pre rúry 26x3	50	m	3395310167	1,16	
RP-SANV2	ROZDELOVÁČ/ZBERAČ NA sanitárny rozvod vody (mat.: nerez, vrátane uzatváracích armatúr)			1	ks	1533000297	64,00
RP-SANV3				1	ks	1533000298	75,00
RP-SANV4				1	ks	1533000299	95,00
RP-SANV5				1	ks	1533000300	110,00
RP-SANV6				1	ks	1533000301	124,00
RP-SANV7				1	ks	1533000302	138,00
RP-SANV8				1	ks	1533000303	152,00
RP-SANV9				1	ks	1533000304	166,00
RP-SANV10				1	ks	1533000305	180,00

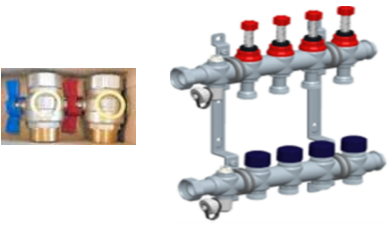
Objednávaci kód	ROZDELOVAČ/ ZBERAČ NA PODLAHOVÉ/ KONVENČNÉ KÚRENIE (mat.: nerez, napúšťací a vypúšťací ventil, manuálny odvzdušňovač, vrátane uzatváracích armatúr)	POČET VÝVODOV	ROZMER mm	Balenie	MJ	Objednávaci SAP kód	Cena EUR/ks
FT-V2M		2	76 x 146	1	ks	1533000384	146,00
FT-V3M		3	76 x 201	1	ks	1533000385	177,00
FT-V4M		4	76 x 256	1	ks	1533000386	201,00
FT-V5M		5	76 x 311	1	ks	1533000387	225,00
FT-V6M		6	76 x 366	1	ks	1533000388	257,00
FT-V7M		7	76 x 421	1	ks	1533000389	278,00
FT-V8M		8	76 x 476	1	ks	1533000390	298,00
FT-V9M		9	76 x 531	1	ks	1533000391	323,00
FT-V10M		10	76 x 586	1	ks	1533000392	349,00
FT-V11M		11	76 x 641	1	ks	1533000393	385,00
FT-V12M		12	76 x 696	1	ks	1533000394	407,00

Objednávaci kód	ROZDELOVAČ/ZBERAČ NA PODLAHOVÉ/ KONVENČNÉ KÚRENIE (mat.: nerez, napúšťací a vypúšťací ventil, automatický odvzdušňovač, vrátane uzatváracích armatúr)	POČET VÝVODOV	ROZMER mm	Balenie	MJ	Objednávaci SAP kód	Cena EUR/ks
FT-V2A		2	76 x 146	1	ks	1533000395	177,00
FT-V3A		3	76 x 201	1	ks	1533000396	205,00
FT-V4A		4	76 x 256	1	ks	1533000397	232,00
FT-V5A		5	76 x 311	1	ks	1533000398	263,00
FT-V6A		6	76 x 366	1	ks	1533000399	305,00
FT-V7A		7	76 x 421	1	ks	1533000400	313,00
FT-V8A		8	76 x 476	1	ks	1533000401	343,00
FT-V9A		9	76 x 531	1	ks	1533000402	370,00
FT-V10A		10	76 x 586	1	ks	1533000403	401,00
FT-V11A		11	76 x 641	1	ks	1533000404	433,00
FT-V12A		12	76 x 696	1	ks	1533000405	465,00

ZMIEŠAVACÍ MIX S ČERPADLOM

FT-RST/F		1	ks	1533000294	487,00
----------	--	---	----	------------	--------

Objednávaci kód	SKRINKA ROZDELOVAČA/ZBERAČA - PODOMIETKOVÁ	POČET OKRUHOV	ROZMER /mm/	Balenie	MJ	Objednávaci SAP kód	Cena EUR/ks	
FT-SK1	nastaviteľná výška 615 - 705 mm	2-4	435	1	ks	3395004756	76,00	
FT-SK2	nastaviteľná hĺbka 110 - 175 mm	4-8	565	1	ks	3395002249	85,00	
FT-SK3		8-10	715	1	ks	3395002250	94,00	
FT-SK4		10-12	795	1	ks	3395002251	100,00	
FT-SK5		12-13	965	1	ks	3395003314	111,00	
		so zmiešavacím mixom						

Objednávaci kód	SKRINKA ROZDELOVAČA/ZBERAČA - NADOMIETKOVÁ	POČET OKRUHOV	ROZMER /mm/	Balenie	MJ	Objednávaci SAP kód	Cena EUR/ks
FT-SA1	výška 600 mm	2-4	420	1	ks	3395005241	74,00
FT-SA2	hĺbka 120 mm	4-8	550	1	ks	3395002983	81,00
FT-SA3		8-10	700	1	ks	3395003000	88,00
FT-SA4		10-12	780	1	ks	3395002247	94,00
FT-SA5		12-13	950	1	ks	3395002248	102,00
		so zmiešavacím mixom					

EUROKÓNUS

RP-KVA16/2,0	Na pripojenie RÚRY 16x2	10/100	ks	1533000329	3,12
RP-KVA17/2,0	Na pripojenie RÚRY 17x2	10/100	ks	1533000330	3,14
FT-KVA18	Na pripojenie RÚRY 18x2	10/100	ks	1533000331	3,16
RP-KVA20/2,0	Na pripojenie RÚRY 20x2	10/100	ks	1533000332	3,18

Objednávaci kód	SPOJKA	PRIEMER mm	Balenie	MJ	Objednávaci SAP kód	Cena EUR/ks
RP-M16		16	10/100	ks	1533000035	3,89
RP-M18		18	10/100	ks	3395002927	5,23
RP-M20		20	10/80	ks	1533000037	4,92
RP-M26		26	5/50	ks	1533000040	7,29
RP-M32		32	5/30	ks	1533000044	11,10
RP-M40		40	1/30	ks	1533000047	18,17
RP-M50		50	1/10	ks	1533000050	33,81
RP-M63		63	1/5	ks	1533000053	67,20

Objednávaci kód	SPOJKA PPSU	PRIEMER mm	Balenie	MJ	Objednávaci SAP kód	Cena EUR/ks
RPK-M16		16	10/100	ks	1533000009	2,91
RPK-M20		20	10/80	ks	1533000011	3,91
RPK-M26		26	5/50	ks	1533000013	5,39
RPK-M32		32	5/30	ks	1533000015	8,21

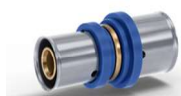
Objednávaci kód	REDUKCIA	PRIEMER mm	Balenie	MJ	Objednávaci SAP kód	Cena EUR/ks
RP-R20/16		20-16	10/80	ks	1533000036	4,58
RP-R26/16		26-16	5/50	ks	1533000038	6,59
RP-R26/20		26-20	5/50	ks	1533000039	6,20
RP-R32/16		32-16	5/50	ks	1533000041	10,20
RP-R32/20		32-20	5/50	ks	1533000042	10,20
RP-R32/26		32-26	5/50	ks	1533000043	10,40
RP-R40/26		40-26	1/30	ks	1533000045	19,20
RP-R40/32		40-32	1/30	ks	1533000046	19,20
RP-R50/26		50-26	1/10	ks	3395002329	34,00
RP-R50/32		50-32	1/10	ks	1533000048	34,00
RP-R50/40		50-40	1/10	ks	1533000049	34,00
RP-R63/40		63-40	1/10	ks	1533000051	72,00
RP-R63/50		63-50	1/10	ks	1533000052	79,00

Objednávaci kód	REDUKCIA PPSU	PRIEMER mm	Balenie	MJ	Objednávaci SAP kód	Cena EUR/ks
RPK-R20/16		20-16	10/80	ks	1533000010	3,73
RPK-R26/20		26-20	5/50	ks	1533000012	4,99
RPK-R32/26		32-26	5/50	ks	1533000014	7,28









ZÁVIT

Objednávaci kód	PRECHOD - VNÚTORNÝ ZÁVIT	PRIEMER mm	Veľkosť závit	Balenie	MJ	Objednávaci SAP kód	Cena EUR/ks
RP-UIG16/1/2		16	1/2"	10/120	ks	1533000137	4,31
RP-UIG20/1/2		20	1/2"	10/120	ks	1533000138	4,52
RP-UIG20/3/4		20	3/4"	10/120	ks	1533000139	5,99
RP-UIG26/3/4		26	3/4"	5/50	ks	1533000140	9,56
RP-UIG26/1		26	1"	5/50	ks	1533000141	9,98
RP-UIG32/1		32	1"	5/30	ks	1533000142	11,50
RP-UIG32/5/4		32	5/4"	5/30	ks	1533000143	17,80
RP-UIG40/1		40	1"	1/20	ks	1533000144	17,70
RP-UIG40/5/4		40	5/4"	1/20	ks	1533000145	23,00
RP-UIG50/6/4		50	6/4"	1/10	ks	1533000146	42,00
RP-UIG63/2		63	2"	1/5	ks	1533000147	72,00

UHOL

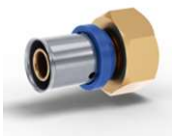
Objednávaci kód	KOLENO 90°	PRIEMER mm	Uhol	Balenie	MJ	Objednávaci SAP kód	Cena EUR/ks
RP-W16/90		16	90°	10/80	ks	1533000159	5,01
RP-W20/90		20	90°	10/80	ks	1533000160	5,88
RP-W26/90		26	90°	5/40	ks	1533000161	8,77
RP-W32/90		32	90°	5/20	ks	1533000162	12,50
RP-W40/90		40	90°	1/15	ks	1533000163	28,00
RP-W50/90		50	90°	1/10	ks	1533000164	48,00
RP-W63/90		63	90°	1/5	ks	1533000165	110,00

Objednávaci kód	KOLENO 90° PPSU	PRIEMER mm	Uhol	Balenie	MJ	Objednávaci SAP kód	Cena EUR/ks
RPK-W16/90		16	90°	10/80	ks	1533000019	3,73
RPK-W20/90		20	90°	10/60	ks	1533000020	4,33
RPK-W26/90		26	90°	5/40	ks	1533000021	6,42
RPK-W32/90		32	90°	5/20	ks	1533000022	8,48

Objednávaci kód		PRIEMER mr	ZÁVIT	Balenie	MJ	Objednávaci SAP kód	Cena EUR/ks
RP-W26/45	KOLENO 45° 	26	45°	5/40	ks	1533000175	16,40
RP-W32/45		32	45°	5/20	ks	1533000176	18,30
RP-W40/45		40	45°	1/20	ks	1533000177	26,00
RP-W50/45		50	45°	1/10	ks	1533000178	44,00
RP-W63/45		63	45°	1/5	ks	1533000179	120,00
RP-UWA16/1/2	KOLENO 90° VONKAJŠÍ ZÁVIT 	16	1/2"	10/80	ks	1533000166	5,57
RP-UWA20/1/2		20	1/2"	10/80	ks	1533000167	6,41
RP-UWA20/3/4		20	3/4"	10/60	ks	1533000168	6,62
RP-UWA26/3/4		26	3/4"	5/40	ks	1533000169	9,03
RP-UWA26/1		26	1"	5/40	ks	1533000170	10,10
RP-UWA32/1		32	1"	5/20	ks	1533000171	14,20
RP-UWA40/5/4	40	5/4"	1/15	ks	1533000172	24,00	
RP-UWI16/1/2	KOLENO 90° VNÚTORNÝ ZÁVIT 	16	1/2"	10/80	ks	1533000180	5,69
RP-UWI20/1/2		20	1/2"	10/80	ks	1533000181	6,41
RP-UWI20/3/4		20	3/4"	10/60	ks	1533000182	8,24
RP-UWI26/3/4		26	3/4"	5/40	ks	1533000183	9,66
RP-UWI26/1		26	1"	5/40	ks	1533000184	10,50
RP-UWI32/1		32	1"	5/20	ks	1533000185	15,30
RP-UWI40/5/4	40	5/4"	1/15	ks	1533000186	26,90	
RP-UAG16/1/2	PRECHOD - VONKAJŠÍ ZÁVIT 	16	1/2"	10/120	ks	1533000125	3,68
RP-UAG16/3/4		16	3/4"	10/120	ks	1533000126	4,11
RP-UAG18/1/2		18	1/2"	10/120	ks	3395002403	4,56
RP-UAG18/3/4		18	3/4"	10/120	ks	3395002936	6,48
RP-UAG20/1/2		20	1/2"	10/120	ks	1533000127	4,01
RP-UAG20/3/4		20	3/4"	10/100	ks	1533000128	5,00
RP-UAG26/3/4		26	3/4"	5/50	ks	1533000129	7,77
RP-UAG26/1		26	1"	5/50	ks	1533000130	8,61
RP-UAG32/1		32	1"	5/30	ks	1533000131	10,40
RP-UAG32/5/4		32	5/4"	5/30	ks	1533000132	13,40
RP-UAG40/1		40	1"	1/20	ks	1533000133	16,50
RP-UAG40/5/4		40	5/4"	1/20	ks	1533000134	19,00
RP-UAG50/6/4		50	6/4"	1/10	ks	1533000135	42,00
RP-UAG63/2	63	2"	1/5	ks	1533000136	75,00	
RP-UPV16/1/2	SPOJKA S PREVLEČNOU MATICOU 	16	1/2"	10/100	ks	1533000148	5,09
RP-UPV16/3/4		16	3/4"	10/100	ks	1533000149	6,11
RP-UPV20/1/2		20	1/2"	10/80	ks	1533000150	5,36
RP-UPV20/3/4		20	3/4"	10/80	ks	1533000151	6,47
RP-UPV20/1		20	1	10/60	ks	1533000152	10,90
RP-UPV26/3/4		26	3/4"	5/50	ks	1533000153	9,03
RP-UPV26/1		26	1"	5/50	ks	1533000154	11,10
RP-UPV32/5/4		32	5/4"	5/30	ks	1533000155	16,20
RP-UPV32/6/4		32	6/4"	5/30	ks	1533000156	22,00
RP-UPV40/5/4		40	5/4"	1/15	ks	1533000157	19,20
RP-UPV40/6/4		40	6/4"	1/15	ks	1533000158	25,00
RP-AAE16/1/2	NÁSTENKA 	16	1/2"	10/40	ks	1533000189	6,43
RP-AAE18/1/2		18	1/2"	10/40	ks	3395002270	8,58
RP-AAE20/1/2		20	1/2"	10/40	ks	1533000190	7,26
RP-AAE20/3/4		20	3/4"	10/30	ks	1533000191	10,10
RP-AAE26/3/4	26	3/4"	5/25	ks	1533000192	10,70	
RP-AAD16/16U	DVOJITÁ NÁSTENKA U 	16-16	1/2"	5/15	ks	1533000194	13,50
RP-AAD20/20U		20-20	1/2"	5/15	ks	1533000195	14,10
RP-AAE16/1/2/80	NÁSTENKA PREDĽŽENÁ 	16	1/2"	5/25	ks	1533000187	10,10
RP-AAE20/1/2/80		20	1/2"	5/25	ks	1533000188	10,60

Objednávaci kód		PRIEMER mr	Balenie	MJ	Objednávaci SAP kód	Cena EUR/ks
RP-T16/18/16	T-KUS REDUKOVANÝ	16-18-16	10/50	ks	3395002848	8,81
RP-T16/20/16		16-20-16	10/50	ks	1533000065	8,98
RP-T18/16/16		18-16-16	10/50	ks	3395002931	9,77
RP-T18/16/18		18-16-18	10/50	ks	3395002339	9,77
RP-T20/16/16		20-16-16	10/50	ks	1533000066	8,42
RP-T20/16/18		20-16-18	10/50	ks	3395002849	9,82
RP-T20/16/20		20-16-20	10/50	ks	1533000006	8,28
RP-T20/18/20		20-18-20	10/50	ks	3395002346	10,20
RP-T20/20/16		20-20-16	10/50	ks	1533000007	9,45
RP-T20/26/20		20-26-20	5/20	ks	1533000068	12,60
RP-T26/16/20		26-16-20	5/20	ks	1533000069	12,50
RP-T26/16/26		26-16-26	5/20	ks	1533000070	12,50
RP-T26/18/18		26-18-18	5/20	ks	3395002850	12,90
RP-T26/18/26		26-18-26	5/20	ks	3395002357	13,40
RP-T26/20/16		26-20-16	5/20	ks	1533000071	13,40
RP-T26/20/20		26-20-20	5/20	ks	1533000072	11,80
RP-T26/20/26		26-20-26	5/20	ks	1533000073	11,90
RP-T26/26/16		26-26-16	5/20	ks	1533000074	12,70
RP-T26/26/20		26-26-20	5/20	ks	1533000075	12,70
RP-T32/16/32		32-16-32	5/20	ks	1533000077	17,80
RP-T32/18/32		32-18-32	5/20	ks	3395002932	18,50
RP-T32/20/26		32-20-26	5/20	ks	1533000078	17,20
RP-T32/20/32		32-20-32	5/20	ks	1533000079	17,20
RP-T32/26/26		32-26-26	5/20	ks	1533000080	16,50
RP-T32/26/32		32-26-32	5/20	ks	1533000081	16,50
RP-T32/32/26		32-32-26	5/20	ks	1533000082	17,50
RP-T40/26/32		40-26-32	1/10	ks	1533000085	31,00
RP-T40/26/40		40-26-40	1/10	ks	1533000086	31,00
RP-T40/32/32		40-32-32	1/10	ks	1533000087	31,00
RP-T40/32/40		40-32-40	1/10	ks	1533000088	31,00
RP-T40/40/26		40-40-26	1/10	ks	1533000089	31,00
RP-T40/40/32		40-40-32	1/10	ks	1533000090	31,00
RP-T50/26/50	50-26-50	1/5	ks	1533000092	55,00	
RP-T50/32/50	50-32-50	1/5	ks	1533000093	64,00	
RP-T50/40/40	50-40-40	1/5	ks	1533000094	59,00	
RP-T50/40/50	50-40-50	1/5	ks	1533000095	61,00	
RP-T50/50/32	50-50-32	1/5	ks	1533000096	61,00	
RP-T50/50/40	50-50-40	1/5	ks	1533000097	61,00	
RP-T63/40/63	63-40-63	1/5	ks	1533000099	132,00	
RP-T63/50/63	63-50-63	1/5	ks	1533000100	135,00	





RPK-T16/20/16	T-KUS REDUKOVANÝ PPSU	16-20-16	10/50	ks	1533000630	8,36
RPK-T20/16/16		20-16-16	10/50	ks	1533000631	8,36
RPK-T20/16/20		20-16-20	10/50	ks	1533000632	8,36
RPK-T20/20/16		20-20-16	10/50	ks	1533000633	8,36
RPK-T20/26/20		20-26-20	5/20	ks	1533000634	12,30
RPK-T26/16/20		26-16-20	5/20	ks	1533000635	12,30
RPK-T26/16/26		26-16-26	5/20	ks	1533000636	12,30
RPK-T26/20/16		26-20-16	5/20	ks	1533000637	12,30
RPK-T26/20/20		26-20-20	5/20	ks	1533000638	12,30
RPK-T26/20/26		26-20-26	5/20	ks	1533000639	12,30
RPK-T26/26/16		26-26-16	5/20	ks	1533000640	12,30
RPK-T26/26/20		26-26-20	5/20	ks	1533000641	12,30
RPK-T32/16/32		32-16-32	5/20	ks	1533000642	17,50
RPK-T32/20/32		32-20-32	5/20	ks	1533000643	17,50
RPK-T32/26/26		32-26-26	5/20	ks	1533000644	17,50
RPK-T32/26/32		32-26-32	5/20	ks	1533000645	17,50



Objednávaci kód		PRIEMER mm	Balenie	MJ	Objednávaci SAP kód	Cena EUR/ks
RP-T16	T-KUS JEDNOZNAČNÝ 	16	10/50	ks	1533000064	6,62
RP-T18		18	10/50	ks	3395002338	10,27
RP-T20		20	10/40	ks	1533000067	8,17
RP-T26		26	5/20	ks	1533000008	11,60
RP-T32		32	5/10	ks	1533000083	18,80
RP-T40		40	1/10	ks	1533000091	32,00
RP-T50		50	1/5	ks	1533000098	59,00
RP-T63		63	1/5	ks	1533000101	139,00



RPK-T16	T-KUS JEDNOZNAČNÝ PPSU 	16	10/50	ks	1533000005	4,82
RPK-T20		20	10/40	ks	1533000016	5,80
RPK-T26		26	5/20	ks	1533000017	8,83
RPK-T32		32	5/10	ks	1533000018	13,70

Objednávaci kód		PRIEMER mm	ZÁVIT	Balenie	MJ	Objednávaci SAP kód	
RP-TA16/1/2	T-KUS VONKAJŠÍ ZÁVIT 	16	1/2"	10/50	ks	1533000102	8,94
RP-TA20/1/2		20	1/2"	10/40	ks	1533000103	9,42
RP-TA20/3/4		20	3/4"	10/40	ks	1533000104	11,90
RP-TA26/1/2		26	1/2"	5/20	ks	1533000105	13,60
RP-TA26/3/4		26	3/4"	5/20	ks	1533000106	13,60
RP-TA26/1		26	1"	5/20	ks	1533000107	13,60
RP-TA32/3/4		32	3/4"	5/20	ks	1533000108	16,10
RP-TA32/1		32	1"	5/15	ks	1533000109	16,10
RP-TA40/1		40	1"	1/10	ks	1533000110	31,00
RP-TA50/5/4		50	5/4"	1/5	ks	1533000111	55,00

RP-TI16/1/2	T-KUS VNÚTORNÝ ZÁVIT 	16	1/2"	10/50	ks	1533000113	8,99
RP-TI20/1/2		20	1/2"	10/40	ks	1533000114	9,77
RP-TI20/3/4		20	3/4"	10/40	ks	1533000115	13,40
RP-TI26/1/2		26	1/2"	5/20	ks	1533000116	14,10
RP-TI26/3/4		26	3/4"	5/20	ks	1533000117	14,10
RP-TI32/1/2		32	1/2"	5/20	ks	1533000118	17,80
RP-TI32/3/4		32	3/4"	5/20	ks	1533000119	17,80
RP-TI32/1		32	1"	5/15	ks	1533000120	17,80
RP-TI40/1		40	1"	1/10	ks	1533000121	28,00
RP-TI40/5/4		40	5/4"	1/10	ks	1533000122	28,00
RP-TI50/5/4		50	5/4"	1/5	ks	1533000123	64,00
RP-TI50/6/4		50	6/4"	1/5	ks	1533000124	67,00

Objednávaci kód			Balenie	MJ	Objednávaci SAP kód	Cena EUR/ks
RP-SSE1	Protihlukový kryt pre RP-AAE...1/2		1/50	ks	1533000003	5,15
RP-SSE3	Protihlukový kryt pre RP-AAE...1/2/80		1/50	ks	1533000004	5,99

MONTÁŽNA KOLAJNICA PRE STENOVÝ PRECHODKU

SI-DHE			1/30	ks	1533000025	6,83
SI-DH100	2 OTVORY ROZTEČ 100 MM		1/15	ks	1533000024	7,52
SI-DH80/153	2 OTVORY ROZTEČ 80/153 MM		1/100	ks	1533000023	5,45
RP-WALP16/1/2			1/30	ks	1533000193	22,00
RP-WALP20/1/2			1/30	ks	1533000481	24,00

Objednávaci kód		Priemer mm	ZÁVIT	Balenie	MJ	Objednávaci SAP kód	
RP-WDF16/1/2	STENOVÝ PRECHOD	16	1/2"	1/20	ks	1533000173	14,10
RP-WDF20/1/2		20	1/2"	1/20	ks	1533000174	14,10

RP-SP16	PODLAHOVÝ PRECHOD - KOLENO		16		1/30	ks	1533000112	11,20
---------	----------------------------	---	----	--	------	----	------------	-------

Objednávaci kód		Priemer mm	Výška	Balenie	MJ	Objednávaci SAP kód	
RP-HKW16/300	KOLENO NA PRIPOJENIE K RADIÁTORU	16	300	1/30	ks	1533000033	13,90
RP-HKW20/300		20	300	1/30	ks	1533000034	14,80

RP-END16	ZÁSLEPKA	16		10/150	ks	1533000058	5,36
RP-END20		20		10/150	ks	1533000059	6,41
RP-END26		26		5/100	ks	1533000060	8,94
RP-END32		32		5/60	ks	1533000061	11,50
RP-END40		40		1/40	ks	1533000062	17,90
RP-END50		50		1/30	ks	1533000063	27,00

RP-PH16	LISOVACÍ KRÚŽOK	16		1	ks	1533000026	0,92
RP-PH20		20		1	ks	1533000027	1,18
RP-PH26		26		1	ks	1533000028	1,76
RP-PH32		32		1	ks	1533000029	2,04
RP-PH40		40		1	ks	1533000030	3,78
RP-PH50		50		1	ks	1533000031	5,29
RP-PH63		63		1	ks	1533000032	11,50

SI-HAK60	HMOŽDINOVÁ KOTVA NA RÚRU	60 mm		50ks/bal	bal	3395002471	22,00
SI-DUOHAK60		60 mm		50ks/bal	bal	3395002470	28,00

RP-EK10	KALIBRÁTOR	10		1	ks	3395005028	64,00
RP-EK16		16		1	ks	3395002282	64,00
RP-EK18		18		1	ks	3395002284	64,00
RP-EK20		20		1	ks	3395002285	68,00
RP-EK26		26		1	ks	3395002286	68,00
RP-EK32		32		1	ks	3395002844	82,00
RP-EK40		40		1	ks	3395002287	90,00
RP-EK50		50		1	ks	3395002845	100,00
RP-EK63		63		1	ks	RP-EK63	129,00

RP-EK16/26	ZDRUŽENÝ KALIBRÁTOR	16-18-20-26		1	ks	3395002283	35,00
RP-EK16/32		16-20-26-32		1	ks	1533000499	81,00
RP-EK16/20/26		16-20-26		1	ks	1533000498	15,00

Objednávaci kód		Balenie	MJ	Objednávaci SAP kód	Cena EUR/ks
	IZOLÁCIA NA PODLAHOVÉ KÚRENIE				
FT-FOLIE	fólia hliníková - 50 m2	1	bal	FT-FOLIE	111,00
FT-DESK SOLO 14-17	systémová fólia pre 14 - 17 mm, 1 ks = 1,12m2	1/20/130	m ²	FT-DESK SOLO 14-17	11,30
FT-DESK SOLO 16-18	systémová fólia pre 16 - 18 mm, 1 ks = 1,12m2	1/20/130	m ²	FT-DESK SOLO 16-18	11,30
FT-ROLLE+	izolácia hrúbky 30 mm, s alu fóliou a rastrom, max. zaťaženie 3,5 kN/m2 (pri objednávke 1bal=10m2)	1	bal	3395002246	97,00
FT-DESK SILENZIO	systémová doska SILENZIO ND 30-2 1450x850mm, hrúbka 30mm balenie 6ks (6,72m2) (pri objednávke 1ks=1,12m2)	1/6	m ²	3395002243	14,90
FT-DESK DURO ND 10	systémová doska SILENZIO ND 10 1450x850mm, hrúbka 10mm balenie 12ks (13,44m2) (pri objednávke 1ks=1,12m2)	1/12	m ²	3395002242	12,90
FT-DESK EASY 1625	systémová doska pre suchú pokládku EPS300	1/5	m ²	3395002830	50,00
FT-DESK EASY 1617	vrátane hliníkovej vrstvy, rozteč 192mm	1/10	m ²	FT-DESK EASY 1617	49,00
FT-DESK 1620	1175x768mm, hrúbka 17 alebo 25mm	1/10	m ²	3395005312	40,00
FT-DESK 1625	balenie 5ks (4,5m2), 10ks (9m2)	1/5	m ²	3395005313	41,00
FT-DESK 1630	(pri objednávke 1ks=0,90m2)	1/5	m ²	3395005314	43,00
FT-TACKGERAT	upevňovacia tyč	1	ks	3395002831	239,00
RP-UCT	odvíjač rúr	1	ks	3395002418	192,00
FT-TACKNAD	upevňovacie prýchytky	200 ks/bal	bal	3395002252	20,00
FT-TACKNAD-40		300 ks/bal	bal	3395005310	8,33
FT-TACKNAD-50		300 ks/bal	bal	3395005237	8,71
FT-TACKNAD-60		300 ks/bal	bal	3395005311	8,90
FT-TACKNAD-600		600 ks/bal	bal	FT-TACKNAD-600	32,00
FT-RAND16KF	obvodová dilatačná páska výška 125+35mm 25m	1 ks / 25 m	ks	3395005308	19,00
FT-RAND16KF-50	obvodová dilatačná páska výška 125+35mm 50m	1 ks / 50 m	ks	3395002245	36,00
RP-ACT1	Termoelektrický servopohon 230 V	1	ks	1533000325	15,00
RP-ACT2	Termoelektrický servopohon 24 V	1	ks	1533000868	34,80
RP-EGO	Adaptívny servopohon prietoku 230 V	1	ks	1533000326	64,00
WH-1022-L	Základná zbernica Master	1	ks	3395005053	590,00
WH-DPLT-L	Elektronický termostat s digitálnym displejom	1	ks	3395005057	153,00
WH-EYMIX-L	ovládanie zmiešavacieho ventilu	1	ks	3395005055	670,00
WH-PS12V-L	trafo napätia	1	ks	3395005054	46,00

Objednávaci kód		Balenie	MJ	Objednávaci SAP kód	Cena EUR/ks
FT-DS1 V2	termostat BASIC	1	ks	1533000500	43,00
FT-SLIMLINE RF V2	termostat Slimline RF	1	ks	3295430171	134,00
FT-PLF THERMOSTAT	termostat P	1	ks	1533000649	91,00
FT-NEOSTAT V3	termostat S	1	ks	1533000504	163,00
FT-NEOAIR V3	termostat SW RF	1	ks	1533000503	163,00
FT-UH6	zbernica 6 zón, 230 V	1	ks	1533000501	145,00
FT-UH8	zbernica 8 zón, 230 V	1	ks	1533000511	148,00
FT-UH8RF V2	zbernica 8 zón, 230 V, RF	1	ks	1533000502	287,00
FT-BOOST UFH	Boost	1	ks	1533000646	111,00
FT-RF SWITCH	RF switch	1	ks	1533000509	97,00
FT-NEOHUB	router neoHUB RF	1	ks	1533000510	305,00
FT-AIR SENSOR RF	snímač teploty vzduchu RF	1	ks	1533000647	35,00
FT-FLOOR SENSOR	snímač teploty podlahy	1	ks	1533000505	14,10
FT-THIMBLE SENSOR	snímač teploty vzduchu	1	ks	1533000506	37,00

NÁRADIE

RE-ELPRESS10-54	LISOVACIE KLIESTE		Základný balík: kliešte, kufor z oceľového plechu	1	ks	3395002943	3770,00
-----------------	-------------------	---	---	---	----	------------	---------









LISOVACIE KLIESTE AKU

RE-AKPRESS16-110		Základný balík : kliešte, akumulátor, nabíjačka, kufor z oceľového plechu	1	ks	3395002832	4155,00
RE-AKPRESS16-32 mini			1	ks	3395002833	3565,00
RE-ECOPRESS		mechanické lisovacie kliešte	1	ks	3395002265	470,00

RE-PRESSZ10	LISOVACIE ČELUSTE - TH PROFIL	10	1	ks	3395005027	330,00
RE-PRESSZ16		16	1	ks	3395002834	330,00
RE-PRESSZ18		18	1	ks	3395002835	330,00
RE-PRESSZ20		20	1	ks	3395002836	330,00
RE-PRESSZ26		26	1	ks	3395002837	330,00
RE-PRESSZ32		32	1	ks	3395002838	330,00
RE-PRESSZ40		40	1	ks	3395002839	340,00
RE-PRESSZ50		50	1	ks	3395002840	978,00
RE-PRESSZ63	63	1	ks	3395002841	978,00	

2427	NOŽNICE		do priemeru 42 mm	1	ks	3395002240	78,00
1855			do priemeru 63 mm	1	ks	1855	271,00

RADOPRESS WATT

Objednávaci kód		PRIEMER mm	Balenie	MJ	Objednávaci SAP kód	Cena EUR/m	
WH-10x1,3-120	PE-RT/EVOH/PE-RT rúra na podlahové kúrenie a chladenie s kyslíkovou bariérou	10X1,3 mm	120	m	3395004353	1,18	
WH-10x1,3-240		10X1,3 mm	240	m	3395004976	1,18	
							
RP16x2-200PERT_U	VIACVRSTVOVÁ RÚRKA S HLINÍKOVOU VRSTVOU	PE-RT/AL/PE-RT 16x2,0 mm	200	m	3395310111	1,08	
RP16x2-400PERT_U		PE-RT/AL/PE-RT 16x2,0 mm	400	m	3395310113	1,08	
RP16x2-600-PERT_U		PE-RT/AL/PE-RT 16x2,0 mm	600	m	3395310115	1,08	
RP20x2-100PERT_U		PE-RT/AL/PE-RT 20x2,0 mm	100	m	3395310126	1,78	
							
PREDIZOLOVANÁ RÚRA PE-RT/AL/PE-RT, 6mm izolácia							
RP16X2-50PERT-IB	modrá		16x2,0 mm	50	m	3395310115	2,04
RP16X2-50PERT-IR	červená		16x2,0 mm	50	m	3395310117	2,04
RP20X2-50PERT-IB	modrá		18x2,0 mm	50	m	3395310128	2,46
RP20X2-50PERT-IR	červená		18x2,0 mm	50	m	3395310130	2,46
RP26X3-50PERT-IB	modrá		20x2,0 mm	50	m	3395310147	4,47
RP26X3-50PERT-IR	červená		20x2,0 mm	50	m	3395310148	4,47
CHRÁNIČKA - PE korugovaná rúra							
RP-PROT16-50R	červená		pre rúry 16x2	50	m	3395310162	0,70
RP-PROT16-50B	modrá		pre rúry 16x2	50	m	3395310160	0,70
RP-PROT16-50BK	čierna		pre rúry 16x2	50	m	3395310161	0,70
RP-PROT20-50R	červená		pre rúry 20x2	50	m	3395310165	0,75
RP-PROT20-50B	modrá		pre rúry 20x2	50	m	3395310163	0,75
RP-PROT20-50BK	čierna	pre rúry 20x2	50	m	3395310164	0,75	
PEP20/2.5MMU.II	TVRDÁ CHRÁNIČKA		20	2,5	m	PEP20/2.5MMU.II	1,26
PEP20/2.5MMU.IIT			20	2,5	m	PEP20/2.5MMU.IIT	1,26
WH-FR10/2M	MONTÁŽNA LIŠTA		pre 10 mm	2	m	WH-FR10/2M	6,07
WH-FR16/2M			pre 16 mm	2	m	WH-FR16/2M	6,82
WH-FR20/2M			pre 20 mm	2	m	WH-FR20/2M	8,18
WH-SLBOX	PRECHODKA			1	ks	WH-SLBOX	4,92
WH-IV10	OBLÚK VODIACI		pre 10 mm	1	ks	3395004977	1,64
FT-IV18			pre 18 mm			3395005160	3,50
FT-IV20			pre 20 mm				3,50

RADOPRESS WATT

Objednávaci kód	ROZMER mm	Balenie	MJ	Objednávaci SAP kód	Cena EUR/ks
WH-GR151/1	1200 X 2000	1	ks	3395004979	245,00
WH-GR151/2K	1200 X 1000	1	ks	3395004980	126,00
WH-GR151/2H	600 x 2000	1	ks	3395004981	126,00
WH-GR151/4	600 X 1000	1	ks	3395004982	62,00

SDK KÚRENIE / CHLADENIE PANEL

15mm sdk

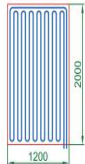

Objednávaci kód	ROZMER mm	Balenie	MJ	Objednávaci SAP kód	Cena EUR/ks
WH-CDP-1000	336 X 1000	1/6	ks	3395004983	33,00
WH-CDP-1100	336 X 1100	1/6	ks	3395004984	39,00
WH-CDP-1200	336 X 1200	1/6	ks	3395004985	42,00
WH-CDP-1300	336 X 1300	1/6	ks	3395004986	45,00
WH-CDP-1400	336 X 1400	1/6	ks	3395004987	48,00
WH-CDP-1500	336 X 1500	1/6	ks	3395004988	52,00
WH-CDP-1600	336 X 1600	1/6	ks	3395004989	55,00
WH-CDP-1700	336 X 1700	1/6	ks	3395004990	58,00
WH-CDP-1800	336 X 1800	1/6	ks	3395004991	62,00
WH-CDP-1900	336 X 1900	1/6	ks	3395004992	68,00
WH-CDP-2000	336 X 2000	1/6	ks	3395004993	72,00
WH-CDP-2100	336 X 2100	1/6	ks	3395004994	75,00
WH-CDP-2200	336 X 2200	1/6	ks	3395004995	77,00
WH-CDP-2300	336 X 2300	1/6	ks	3395004996	82,00
WH-CDP-2400	336 X 2400	1/6	ks	3395004997	85,00
WH-CDP-2500	336 X 2500	1/6	ks	3395004998	92,00

PANELY PRE PODHLADY



Objednávaci kód	ROZMER mm	Balenie	MJ	Objednávaci SAP kód	Cena EUR/ks
WH-SL16		1	m2	3395005015	75,80
WH-KP 150		1	m2	WH-KP 150	95,0
WH-KP 100		1	m2	WH-KP 100	95,0

PREFABRIKOVANÝ MODUL NA OCEĽOVEJ VÝSTUŽI



klíma panel na jemnej sieti - rozteč trubiek 150 mm

klíma panel na jemnej sieti - rozteč trubiek 100 mm

Objednávaci kód	ROZMER mm	Balenie	MJ	Objednávaci SAP kód	Cena EUR/ks
WH-M10	10	1/10	ks	3395005018	6,54

SPOJKA



Objednávaci kód	ROZMER mm	Balenie	MJ	Objednávaci SAP kód	Cena EUR/ks	
WH-UAG10/1/2	10	1/2"	1/10	ks	3395005019	6,80

PRECHOD - VONKAJŠÍ ZÁVIT

ZÁVIT



Objednávaci kód	ROZMER mm	Balenie	MJ	Objednávaci SAP kód	Cena EUR/ks
WH-R16/10	16/10	1/10	ks	3395005020	8,20
WH-R20/10	20/10	1/10	ks	3395005021	9,70

REDUKCIA



Objednávaci kód	ROZMER mm	Balenie	MJ	Objednávaci SAP kód	Cena EUR/ks
WH-T10	10	1/10	ks	3395005022	11,50
WH-T16/10/16	16/10/16	1/10	ks	3395005023	12,30
WH-T20/10/20	20/10/20	1/10	ks	3395005024	13,10

T-KUS



Objednávaci kód	ROZMER mm	Balenie	MJ	Objednávaci SAP kód	Cena EUR/ks	
WH-KVA10/3/4	10	3/4"	1	ks	3395005025	7,10

SPOJKA S PREVLEČNOU MATICOU





Objednávaci kód	ROZMER mm	Balenie	MJ	Objednávaci SAP kód	Cena EUR/ks	
WH-SPV		1"	1	ks	3395005026	225,00

ODLUČOVAČ MIKROBUBLINIEK



RADOPRESS WATT

Objednávaci kód	ROZDELOVAČ/ZBERAČ NA PODLAHOVÉ KÚRENIE (mat.: nerez, napúšťací a vypúšťací ventil, automatický odvzdušňovač, vrátane uzatváracích armatúr)	POČET	ROZMER	Balenie	MJ	Objednávaci SAP kód	Cena EUR/ks
		VÝVODOV	mm				
FT-V2A		2	76 x 146	1	ks	1533000395	177,00
FT-V3A		3	76 x 201	1	ks	1533000396	205,00
FT-V4A		4	76 x 256	1	ks	1533000397	232,00
FT-V5A		5	76 x 311	1	ks	1533000398	263,00
FT-V6A		6	76 x 366	1	ks	1533000399	305,00
FT-V7A		7	76 x 421	1	ks	1533000400	313,00
FT-V8A		8	76 x 476	1	ks	1533000401	343,00
FT-V9A		9	76 x 531	1	ks	1533000402	370,00
FT-V10A		10	76 x 586	1	ks	1533000403	401,00
FT-V11A		11	76 x 641	1	ks	1533000404	433,00
FT-V12A		12	76 x 696	1	ks	1533000405	465,00

Objednávaci kód	SKRINKA ROZDELOVAČA/ZBERAČA - PODOMIETKOVÁ	POČET	ROZMER	Balenie	MJ	Objednávaci SAP kód	Cena EUR/ks	
		OKRUHOV	/mm/					
FT-SK1	nastaviteľná výška 615 - 705 mm	2-4	435	1	ks	3395004756	76,00	
FT-SK2	nastaviteľná hĺbka 110 - 175 mm	4-8	565	1	ks	3395002249	85,00	
FT-SK3		8-10	715	1	ks	3395002250	94,00	
FT-SK4		10-12	795	1	ks	3395002251	100,00	
FT-SK5		12-13	965	1	ks	3395003314	111,00	
		so zmiešavacím mixom						

Objednávaci kód	SKRINKA ROZDELOVAČA/ZBERAČA - NADOMIETKOVÁ	POČET	ROZMER	Balenie	MJ	Objednávaci SAP kód	Cena EUR/ks	
		OKRUHOV	/mm/					
FT-SA1	výška 600 mm	2-4	420	1	ks	3395005241	74,00	
FT-SA2	hĺbka 120 mm	4-8	550	1	ks	3395002983	81,00	
FT-SA3		8-10	700	1	ks	3395003000	88,00	
FT-SA4		10-12	780	1	ks	3395002247	94,00	
FT-SA5		12-13	950	1	ks	3395002248	102,00	
		so zmiešavacím mixom						

EUROKÓNUS







RP-KVA16/2,0	Na pripojenie RÚRY 16x2	16	10/100	ks	1533000329	3,12
RP-KVA17/2,0	Na pripojenie RÚRY 17x2	17	10/100	ks	1533000330	3,14
FT-KVA18	Na pripojenie RÚRY 18x2	18	10/100	ks	1533000331	3,16
RP-KVA20/2,0	Na pripojenie RÚRY 20x2	20	10/100	ks	1533000332	3,18

SI-HAK60	HMOŽDINOVÁ KOTVA NA RÚRU	60 mm	50ks/bal	bal	3395002471	22,00
SI-DUOHAK60		60 mm	50ks/bal	bal	3395002470	28,00

Objednávaci kód	KALIBRÁTOR	POČET	ROZMER	Balenie	MJ	Objednávaci SAP kód	Cena EUR/ks
			mm				
RP-EK10		10	10	1	ks	3395005028	64,00
RP-EK16		16	16	1	ks	3395002282	64,00
RP-EK18		18	18	1	ks	3395002284	64,00
RP-EK20		20	20	1	ks	3395002285	68,00

RE-PRESSZ10	LISOVACIE ČELUSTE - TH PROFIL	10	1	ks	3395005027	330,00
RE-PRESSZ16		16	1	ks	3395002834	330,00
RE-PRESSZ18		18	1	ks	3395002835	330,00
RE-PRESSZ20		20	1	ks	3395002836	330,00

RADOPRESS WATT

Objednávaci kód			Balenie	MJ	Objednávaci SAP kód	Cena EUR/ks	
2427	NOŽNICE		do priemeru 42 mm	1	ks	3395002240	78,00
1855			do priemeru 63 mm	1	ks	1855	271,00
RP-UCT	odvíjač rúr			1	ks	3395002418	192,00
RP-ACT1	Termoelektrický servopohon 230 V			1	ks	1533000325	15,00
RP-ACT2	Termoelektrický servopohon 24 V			1	ks	1533000868	34,80
RP-EGO	Adaptívny servopohon prietoku 230 V			1	ks	1533000326	64,00
WH-1022-L	Základná zbernica Master			1	ks	3395005053	590,00
WH-DPLT-L	Elektronický termostat s digitálnym displejom			1	ks	3395005057	153,00
WH-EYMIX-L	ovládanie zmiešavacieho ventilu			1	ks	3395005055	670,00
WH-PS12V-L	trafo napätia			1	ks	3395005054	46,00
WH-PASM25	Zmiešavací blok			1	ks	WH-PASM25	962,00
WH-V3GB	3 cestný rotačný ventil s pohonom			1	ks	3395005045	236,00
WH-VB32-2	Zmiešavací blok rozdeľovača			1	ks	WH-VB32-2	368,00
WH-VB32-3			1	ks	WH-VB32-3	510,00	
WH-VB32-4			1	ks	WH-VB32-4	870,00	
WH-VB32-5			1	ks	WH-VB32-5	1020,00	
WH-VB32	Konzola rozdeľovača		1	ks	WH-VB32	38,00	
WH-HWQ60/80	Hydraulický separátor			1	ks	WH-HWQ60/80	218,00

Objednávaci kód	SINGLE pre vykurovanie		Objednávaci SAP kód	Cena EUR/m	
H7525	distribučná trubka zo sieťovaného PE-Xa s kyslíkovou bariérou		75/25x2,3	3395004417	31,00
H11025	viacvrstvá tepelná izolácia zo sieťovanej mikrobunečnej PE-X peny		110/25x2,3	3395004418	40,00
H9032	s vodoodpudivou štruktúrou uzavrených buniek		90/32x2,9	3395004419	38,00
H11032	UV odolný dvojstenný korugovaný HDPE plášť		110/32x2,9	3395004420	43,00
H9040			90/40x3,7	3395005269	42,00
H11040			110/40x3,7	3395004421	47,00
H14040			140/40x3,7	3395004422	61,00
H14050			140/50x4,6	3395004423	67,00
H16050			160/50x4,6	3395004424	64,00
H14063			140/63x5,8	3395004425	78,00
H16063			160/63x5,8	3395004426	79,00
H16075			160/75x6,8	3395004427	92,00
H20075			200/75x6,8	3395004428	94,00
H16090			160/90x8,2	3395004429	120,00
H20090			200/90x8,2	3395004430	122,00
H22590			225/90x8,2	3395004431	150,00
H200110			200/110x10,0	3395004432	139,00
H225110			225/110x10,0	3395004433	167,00
H200125			200/125x11,4	3395004434	213,00
H225125			225/125x11,4	3395004435	222,00

TWIN pre vykurovanie

HD14025	distribučné trubky zo sieťovaného PE-Xa		140/25x2,3	3395004436	60,00
HD16025	s kyslíkovou bariérou		160/25x2,3	3395004437	62,00
HD14032			140/32x2,9	3395004438	65,00
HD16032			160/32x2,9	3395005126	67,00
HD14040			140/40x3,7	3395005135	65,00
HD16040			160/40x3,7	3395004439	74,00
HD16050			160/50x4,6	3395004440	115,00
HD20050			200/50x4,6	3395004441	116,00
HD20063			200/63x5,8	3395004442	134,00
HD22563			225/63x5,8	3395004443	152,00
HD22575			225/75x6,8	3395005151	190,00

SINGLE pre teplú vodu

S7525	distribučná trubka z číreho až bieleho PE-X		75/25x3,5	3395004444	37,00
S9032	viacvrstvá tepelná izolácia zo sieťovanej mikrobunečnej PE-X peny		90/32x4,4	3395004445	46,00
S14032	s vodoodpudivou štruktúrou uzavrených buniek		140/32x4,4	3395004446	59,00
S16032	UV odolný dvojstenný korugovaný HDPE plášť		160/32x4,4	3395004447	73,00
S9040			90/40x5,5	3395004448	60,00
S14040			140/40x5,5	3395004449	70,00
S16040			160/40x5,5	3395004450	76,00
S14050			140/50x6,9	3395004451	83,00
S16050			160/50x6,9	3395004452	84,00
S14063			140/63x8,6	3395004453	102,00
S16063			160/63x8,6	3395004454	108,00
S16075			160/75x10,3	3395005138	119,00
S20075			200/75x10,3	S20075	129,00
S16090			160/90x12,3	3395005324	149,00
S20090			200/90x12,3	S20090	169,00
S200110			200/110x15,1	S200110	199,00

Objednávaci kód	TWIN pre teplú vodu		Objednávaci SAP kód	Cena EUR/m
SD1402520	distribučná trubka z čireho až bieleho PE-X		140/25x3,5-20x2,8	3395004455 58,00
SD16025			160/25x3,5-25x3,5	3395004456 67,00
SD1403225			140/32x4,4-25x3,5	3395004457 68,00
SD1603225			160/32x4,4-25x3,5	3395004458 73,00
SD1604025			160/40x5,5-25x3,5	3395004459 83,00
SD1605025			160/50x6,9-25x3,5	3395004460 95,00
SD1605032			160/50x6,9-32x4,4	3395004461 105,00







QUATTRO pre vykurovanie a teplú vodu				
Q160H25S2520	distribučné trubky zo sieťovaného PE-Xa		160/25x2,3-25x3,5-20x2,8	3395004462 86,00
Q160H32S2520	s kyslíkovou bariérou		160/32x2,9-25x3,5-20x2,8	3395004463 88,00
Q160H32S3225			160/32x2,9-32x4,4-25x3,5	3395004464 104,00
Q200H40S4032			200/40x3,7-40x5,5-32x4,4	3395004465 150,00

HEAT PUMP				
HP14032	distribučné trubky zo sieťovaného		140/32x2,9	3395004483 85,00
HP16040	PE-Xa s kyslíkovou bariérou		160/40x3,7	3395004484 125,00
HP16050			160/50x4,6	HP16050 135,00

SINGLE pre studenú vodu a chladienie				
C7525	distribučná trubka z vysokohustotného PE súlade s EN 12 201-2 (tlak PN16)		75/25x2,3	3395004466 25,00
C9032	viacvrstvá tepelná izolácia zo sieťovanej mikrobunečnej PE-X peny		90/32x2,9	3395004467 34,00
C9040	s vodoodpudivou štruktúrou uzavrených buniek		90/40x3,7	3395004468 35,00
C14050	UV odolný dvojstenný korugovaný HDPE plášť		140/50x4,6	3395004469 49,00
C14063			140/63x5,8	3395004470 54,00
C16075			160/75x6,8	3395004471 65,00
C16090			160/90x8,2	3395004472 76,00
C200110			200/110x10,0	3395004473 115,00
C200125			200/125x11,4	3395004474 155,00

SINGLE FROST pre studenú vodu a chladienie s ochranou proti mrazu				
C7525W10	distribučná trubka z vysokohustotného PE súlade s EN 12 201-2 (tlak PN16)		75/25x2,3	3395005184 62,00
C7532W10	integrovateľný samoregulačný vyhrievací kábel 10 W/m		75/32x2,9	3395004475 62,00
C9040W10			90/40x3,7	3395004476 67,00
C14050W10			140/50x4,6	3395004477 89,00
C14063W10			140/63x5,8	3395004478 93,00
C16075W10			160/75x6,8	3395004479 107,00
C16090W10			160/90x8,2	3395004480 121,00
C200110W10			200/110x10,0	3395004481 167,00
C200125W10			200/125x11,4	3395004482 187,00

Príslušenstvo pre verziu s ochranou proti mrazu				
HCTHERM			termostat	3395004672 250,00
HCBOX			rozvodná krabica	3395004673 13,00
HCSL			El. pripojovacia a izolačná sada	3395004674 75,00

Objednávaci kód			Objednávaci SAP kód	Cena EUR/ks	
HC25/0.75M		PE-X prechodky so závitom SDR 11	25x3/4"	3395004485	21,00
HC32/1M			32x1"	3395004486	27,00
HC40/1.25M			40x5/4"	3395004487	39,00
HC50/1.5M			50x6/4"	3395004488	49,00
HC63/2M			63x2"	3395004489	85,00
HC75/2.5M			75x2,5"	3395004490	142,00
HC90/3M			90x3"	3395004491	193,00
HC110/4M			110x4"	3395004492	345,00
HC125/4M			125x4"	3395004493	399,00
SC20/0.75M		PE-X prechodky so závitom SDR 7.4	20x3/4"	3395004521	21,00
SC25/0.75M			25x3/4"	3395004522	22,00
SC32/1M			32x1"	3395004523	28,00
SC40/1.25M			40x5/4"	3395004524	40,00
SC50/1.5M			50x6/4"	3395004525	55,00
SC63/2M			63x2"	3395004526	90,00
SC75/2.5M			75x2,5"	3395005139	150,00
SC90/3M			3"	3395005325	222,00
SC110/4M			4"	SC110/4M	333,00
HC25x25		PE-X x PE-X spojky SDR 11	25x25	3395004494	37,00
HC32x32			32x32	3395004495	42,00
HC40x40			40x40	3395004496	61,00
HC50x50			50x50	3395004497	95,00
HC63x63			63x63	3395004498	125,00
HC75x75			75x75	3395004499	250,00
HC90x90			90x90	3395004500	324,00
HC110x110			110x110	3395004501	490,00
HC125x125			125x125	3395004502	650,00
HLC25x25		PE-X kolená SDR 11	25	3395004503	53,00
HLC32x32			32	3395004504	75,00
HLC40x40			40	3395004505	120,00
HLC50x50			50	3395004506	159,00
HLC63x63			63	3395004507	262,00
HLC75x75			75	3395004508	480,00
HLC90x90			90	3395004509	700,00
HLC110x110			110	3395004510	750,00
HLC125x125			125	3395004511	1308,00
HC25/27W		PE-X prechodky s navarovacím nátrubkom SDR11	25x26,9	3395004512	19,00
HC32/33W			32x33,7	3395004513	27,00
HC40/42W			40x42,4	3395004514	50,00
HC50/48W			50x48,3	3395004515	73,00
HC63/60W			63x60,3	3395004516	111,00
HC75/76W			75x76,1	3395004517	150,00
HC90/89W			90x88,9	3395004518	248,00
HC110/114W			110x114,3	3395004519	361,00
HC125/114W			125x114,3	3395004520	599,00
FP0.75		Upevňovacie body	3/4"	3395004527	16,00
FP1			1"	3395004528	29,00
FP1.25			5/4"	3395004529	55,00
FP1.5			6/4"	3395004530	73,00
FP2			2"	3395004531	89,00
FP2.5			2,5"	3395004532	150,00
FP3			3"	3395004533	250,00
FP4			4"	3395004534	409,00







Objednávaci kód			Objednávaci SAP kód	Cena EUR/ks	
SL0.75	Spojky		3/4"	3395004535	10,00
SL1			1"	3395004536	12,00
SL1.25			5/4"	3395004537	19,00
SL1.5			6/4"	3395004538	26,00
SL2			2"	3395004539	37,00
SL2.5			2,5"	3395004540	95,00
SL3			3"	3395004541	139,00
SL4			4"	3395004542	203,00

Objednávaci kód					
EL0.75	Kolena (90°)		3/4"	3395004543	14,00
EL1			1"	3395004544	17,00
EL1.25			5/4"	3395004545	23,00
EL1.5			6/4"	3395004546	37,00
EL2			2"	3395004547	56,00
EL2.5			2,5"	3395004548	119,00
EL3			3"	3395004549	139,00
EL4			4"	3395004550	209,00

Objednávaci kód					
TP0.75	T-kusy		3/4"	3395004551	16,00
TP1			1"	3395004552	19,00
TP1.25			5/4"	3395004553	28,00
TP1.5			6/4"	3395004554	44,00
TP2			2"	3395004555	59,00
TP2.5			2,5"	3395004556	125,00
TP3			3"	3395004557	175,00
TP4			4"	3395004558	233,00

Objednávaci kód					
RB1/0.75	Redukcie		1"Mx3/4"F	3395004559	9,00
RB1.25/0.75			5/4"Mx3/4"F	3395004560	18,00
RB1.25/1			5/4"x1"F	3395004561	15,00
RB1.5/0.75			6/4"Mx3/4"F	3395004562	28,00
RB1.5/1			6/4"Mx1"F	3395004563	24,00
RB1.5/1.25			6/4"Mx5/4"F	3395004564	23,00
RB2/0.75			2"Mx3/4"F	3395004565	49,00
RB2/1			2"Mx1"F	3395004566	43,00
RB2/1.25			2"Mx5/4"F	3395004567	35,00
RB2/1.5			2"Mx6/4"F	3395004568	34,00
RB2.5/1.25			2,5"Mx5/4"F	3395004569	89,00
RB2.5/1.5			2,5"Mx6/4"F	3395004570	90,00
RB2.5/2			2,5"Mx2"F	3395004571	81,00
RB3/1			3"Mx1"F	3395004572	169,00
RB3/1.25			3"Mx5/4"F	3395004573	169,00
RB3/1.5			3"Mx6/4"F	3395004574	139,00
RB3/2			3"Mx2"F	3395004575	115,00
RB3/2.5			3"Mx2,5"F	3395004576	105,00
RB4/2			4"Mx2"F	3395004577	305,00
RB4/2.5			4"Mx2,5"F	3395004578	259,00
RB4/3	4"Mx3"F	3395004579	199,00		

Objednávaci kód					
NI0.75	Vsuvky		3/4"	3395004580	9,00
NI1			1"	3395004581	13,90
NI1.25			5/4"	3395004582	27,00
NI1.5			6/4"	3395004583	32,00
NI2			2"	3395004584	49,00
NI2.5			2,5"	3395004585	98,00
NI3			3"	3395004586	139,00
NI4			4"	3395004587	220,00

Objednávaci kód			Objednávaci SAP kód	Cena EUR/ks	
PL0.75	Zátky		3/4"	3395004588	7,00
PL1			1"	3395004589	11,00
PL1.25			5/4"	3395004590	16,00
PL1.5			6/4"	3395004591	21,00
PL2			2"	3395004592	34,00
PL2.5			2,5"	3395004593	79,00
PL3			3"	3395004594	99,00
PL4			4"	3395004595	215,00
BV0.75	Guľové ventily		3/4"	3395004596	46,00
BV1			1"	3395004597	68,00
BV1.25			5/4"	3395004598	126,00
BV1.5			6/4"	3395004599	191,00
BV2			2"	3395004600	263,00
BV2.5			2,5"	3395004601	332,00
BV3			3"	3395004602	459,00
BV4			4"	3395004603	640,00
FL0.75	Príruby		3/4"	3395004604	27,00
FL1			1"	3395004605	30,00
FL1.25			5/4"	3395004606	34,00
FL1.5			6/4"	3395004607	39,00
FL2			2"	3395004608	41,00
FL2.5			2,5"	3395004609	57,00
FL3			3"	3395004610	79,00
FL4			4"	3395004611	89,00
SEC/75	Zmršťovacie zátky SINGLE			3395004877	22,00
SEC/90				3395004881	33,00
SEC/110				3395004882	35,00
SEC/140-S				3395004883	39,00
SEC/140				3395004884	33,00
SEC/160-S				3395004885	39,00
SEC/160				3395004886	36,00
SEC/200-S				3395004887	51,00
SEC/200				3395004888	52,00
SEC/225				3395004889	54,00
SECD/140	Zmršťovacie zátky TWIN			3395004880	49,00
SECD/160				3395004879	55,00
SECD/200-S				3395004930	63,00
SECD/200				3395004931	109,00
SECD225				3395005152	109,00
SECQ/10	Zmršťovacia zátka pre Quattro a Heat Pump			3395004656	129,00
DEC75/25	Prachové zátky SINGLE		75/25	3395004612	15,00
DEC75/32			75/32	3395004613	15,00
DEC90/32			90/32	3395004614	15,00
DEC90/40			90/40	3395004615	15,00
DEC110/25			110/25	3395004616	15,00
DEC110/32			110/32	3395004617	15,00
DEC110/40			110/40	3395004618	15,00
DEC140/32			140/32	3395004619	15,00
DEC140/40			140/40	3395004620	15,00
DEC140/50			140/50	3395004621	15,00
DEC140/63			140/63	3395004622	15,00
DEC160/32			160/32	3395004623	15,00
DEC160/40			160/40	3395004624	15,00

Objednávaci kód		Objednávaci SAP kód	Cena EUR/ks	
DEC160/50		160/50	3395004625	15,00
DEC160/63		160/63	3395004626	15,00
DEC160/75		160/75	3395004627	15,00
DEC160/90		160/90	3395004628	15,00
DEC200/75		200/75	3395004629	15,00
DEC200/90		200/90	3395004630	15,00
DEC200/110		200/110	3395004631	15,00
DEC200/125		200/125	3395004632	15,00
DEC225/90		225/90	3395004633	15,00
DEC225/110		225/110	3395004634	15,00
DEC225/125		225/125	3395004635	15,00

Objednávaci kód	Prachové zátky TWIN			
DECD140/25		140/2x25	3395004636	15,00
DECD140/32		140/2x32	3395004637	15,00
DECD140/40		140/2x40	DECD140/40	15,00
DECD160/25		160/2x25	3395004638	15,00
DECD160/32		160/2x32	3395004639	15,00
DECD160/40		160/2x40	3395004640	15,00
DECD160/50		160/2x50	3395004641	15,00
DECD200/50		200/2x50	3395004642	15,00
DECD200/63		200/2x63	3395004643	15,00
DECD225/63		225/2x63	3395004644	15,00
DECD225/75		225/2x75	DECD225/75	15,00
DECD140/2520		140/25-20	3395004645	15,00
DECD140/3225		140/32-25	3395004646	15,00
DECD160/3225		160/32-25	3395004647	15,00
DECD160/4025		160/40-25	3395004648	15,00
DECD160/5025		160/50-25	3395004650	15,00
DECD160/5032		160/50-32	3395004651	15,00

Objednávaci kód	Prachové zátky QUATTRO			
DECQ140/H32S3225		140/32-32-25	DECQ140/H32S3225	15,00
DECQ160/H25S2520		160/25-25-20	3395004652	15,00
DECQ160/H32S2520		160/32-25-20	3395004653	15,00
DECQ160/H32S3225		160/32-32-25	3395004654	15,00
DECQ 160/H40S4040		160/40-40-40	DECQ 160/H40S4040	15,00
DECQ200/H40S4032		200/40-40-32	3395004655	15,00

Objednávaci kód	Rovný izolačný rukávcec			
SIS90/75			3395004680	79,00
SIS110			3395004679	99,00
SIS140			3395004678	149,00
SIS160			3395004677	179,00
SIS200			3395004676	249,00
SIS225			3395004675	249,00

Objednávaci kód	T-izolačná sada			
TIK140/90		140/110/90	3395004682	368,00
TIK225/140		225/200/160/140	3395004681	546,00

Objednávaci kód	H-izolačná sada	2X(225/200/160/140-1x(200/160/140)	3395004683	787,00
-----------------	-----------------	------------------------------------	------------	--------

Objednávaci kód	L-izolačná sada		3395004684	462,00
-----------------	-----------------	--	------------	--------

Objednávaci kód			Objednávaci SAP kód	Cena EUR/ks		
RAS200/75		Sada redukčných adaptérov pre izolačné sady	3395004687	121,00		
RAS200/90			3395004686	134,00		
RAS200/110			3395004685	145,00		
UIC225/140		Podzemná inšpekčná šachta	225/200/160/140	3395004688	1699,00	
SSL75		Zmršťovacie rukávce pre podzmené kontrolné šachty a opravy	3395004709	12,00		
SSL90/110			3395004710	23,00		
SSL110/125			3395004711	25,00		
SSL140/160			3395004712	28,00		
SSL160/180			3395004713	32,00		
SSL200/225			3395004714	32,00		
SSL225/250			3395004715	40,00		
SCHA9/200		Zostava plášťových manžiet	Priemer	otvor	SCHA9/200	95,00
SCHA7/300			75	120	SCHA7/300	158,00
SCHA6/360			75	150	3395004689	326,00
SCHA8/300			90	130	SCHA8/300	189,00
SCHA9/340			90	150	3395004690	410,00
SCHA10/300			110	150	3395004691	273,00
SCHA13/340			140	200	3395004692	578,00
SCHA14/300			160	200	SCHA13/300	399,00
SCHA9/475			160	250	3395004693	630,00
SCHA9/325			200	250	3395004694	431,00
SCHA12/410			225	300	3395004695	840,00
RS75/150		Tesniaci krúžok	75	150	RS75/150	420,00
RS90/150			90	150	RS90/150	420,00
RS110/150			110	150	RS110/150	420,00
RS140/200			140	200	RS140/200	505,00
RS160/250			160	250	RS160/250	651,00
RS200/250			200	250	RS200/250	683,00
RS225/300			225	300	RS225/300	861,00
WSL75/90		Prechod trubky pre netlakovú vodu	3395004700	37,00		
WSL110			3395004701	39,00		
WSL140/160			3395004702	58,00		
WSL200			3395004703	61,00		
WSL225			3395004704	81,00		
RETAP-H		Opravná páska	šírka x dĺžka	RETAP-H	229,00	
RETAP-C			200mm x10m	150mm x10m	RETAP-C	549,00
TA80/250WB		Výstražná páska modrá	80mm x250m	3395004707	120,00	
TA80/250WR			Výstražná páska červená	80mm x250m	TA80/250WR	120,00

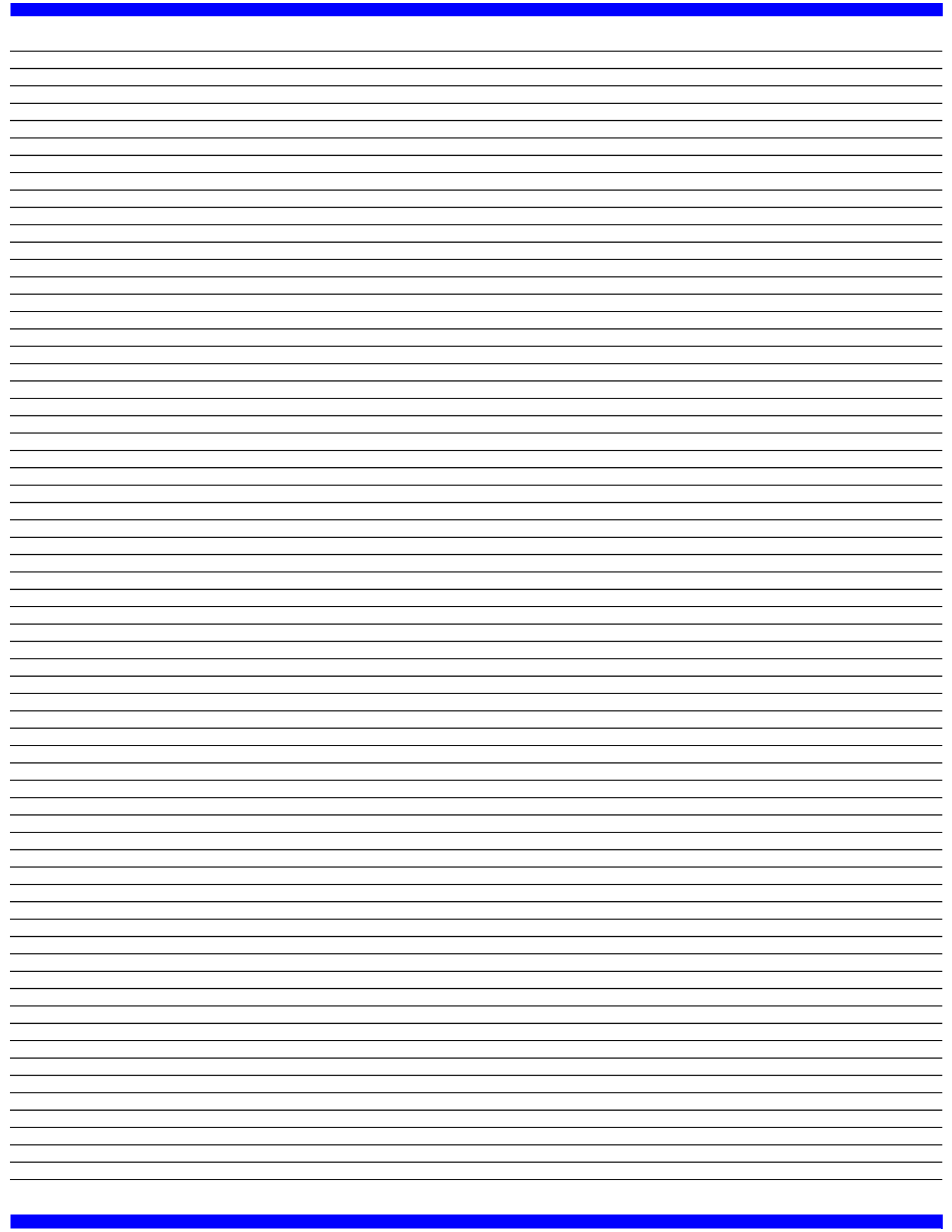



PIPELIFE SLOVAKIA, s.r.o.

Kuzmányho 13, 921 01 Piešťany

Tel.: 033 762 71 79

e-mail: pipelife@pipelife.sk

www.pipelife.sk

 **wienerberger**